

DURAMILL
INDUSTRIAL SUPPLIES
an MSC Company

Email: sales@duramill.ca
Tel: 905-738-8665 | Fax: 905-738-4862
www.duramill.ca
6877 Edwards Blvd., Mississauga, ON L5T 2T9

**UP TO
20% OFF**

**MIC HEADS
PROMO**

MICROMETER HEADS

Measurement and Precision Positioning

Effective through December 15, 2026

Micrometer Heads

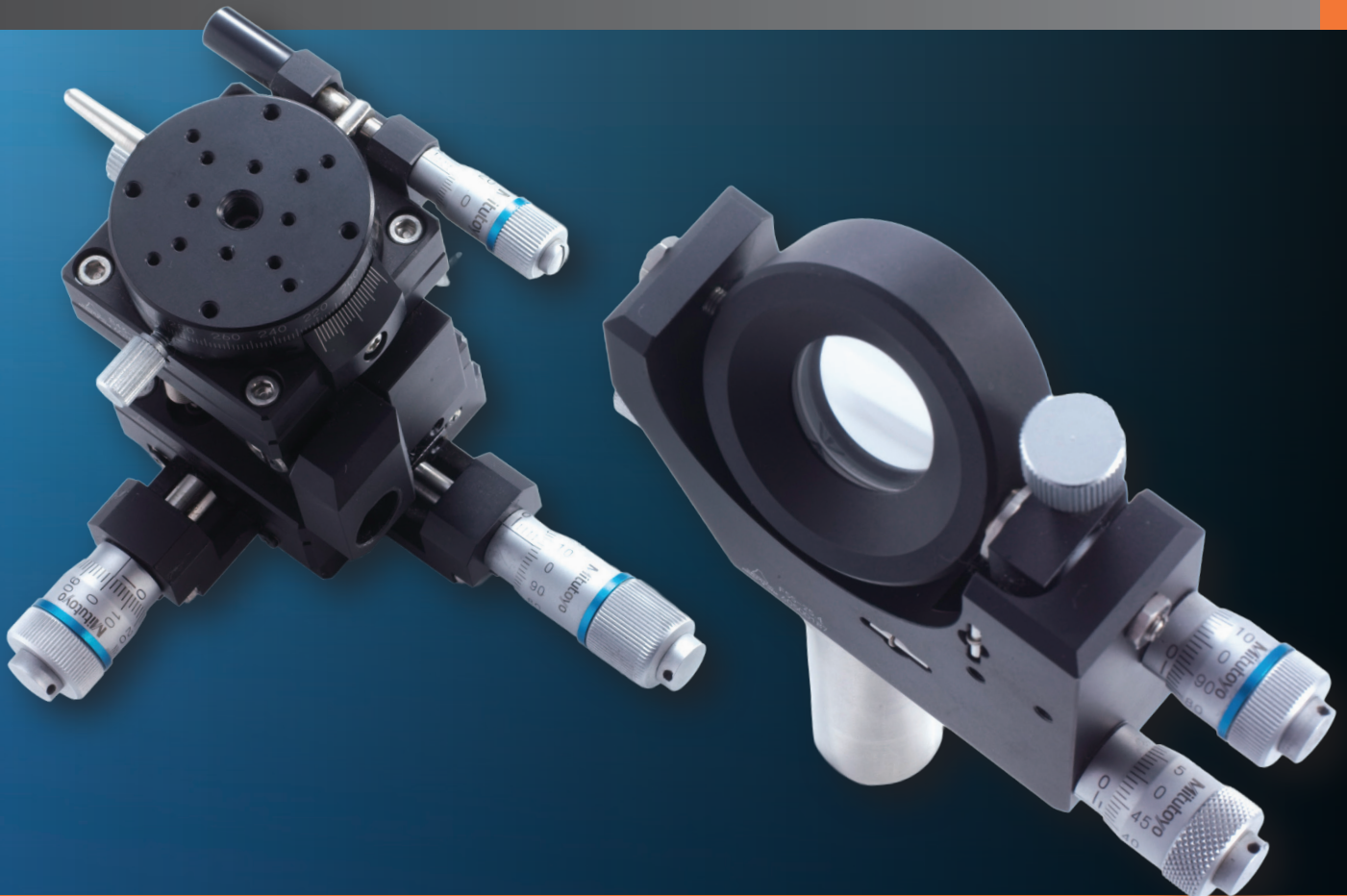



STANDARD HEADS

Standard analog heads offer a choice of measuring range, stem type and body size to suit almost any application.



OEM HEADS

Our micrometer heads are designed specifically for Original Equipment Manufacturers who require consistent, fine adjustment within their instruments, assemblies, and precision mechanisms.



SPECIAL ORDER HEADS

Small quantities of heads, even one-offs, can be supplied to meet a customer's specification of features such as type of spindle tip, thimble graduation, custom engraving, etc.

Micrometer Heads

The origin of Mitutoyo's trustworthy brand of small tool instruments

Mounted on measuring instruments and precision instruments, micrometer heads are used for various purposes including measurement, feeding and positioning. Recent developments in technology have seen the micrometer head widely utilized in precise feeding devices and cross-travel stages on laser instruments and manipulators, in addition to the usual duties on measurement jigs. In parallel with the application expansion, the customer's needs have increased. To meet customer demands, Mitutoyo provides standard micrometer heads with different measuring ranges, stem type and body size. Furthermore, high-performance types of Digimatic Micrometer Head, 0.1 mm spindlepitch models (standard 0.5 mm), etc., are now available for the new applications. Mitutoyo also provides customization services for special applications. Micrometer heads with customized spindle tips and precision leadscrews manufactured to customer specification can be offered even in one-off quantities.

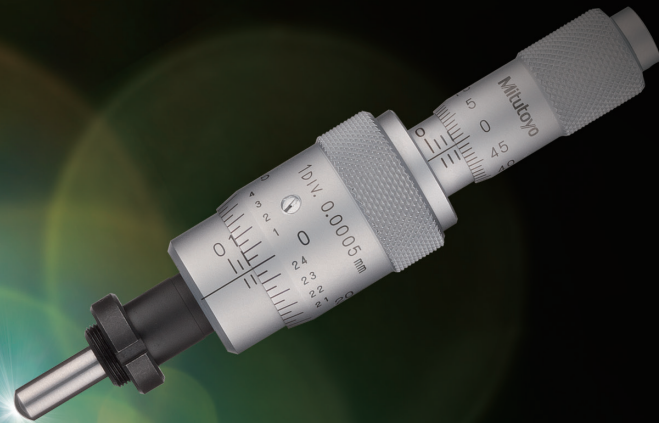

The main production plants for Mitutoyo micrometer heads are Kochi Mitutoyo Corporation Onomi Plant (started operation in 1977) on the upper reaches of the Shimanto River in Shikoku Tosa and Shiwa Production Department (started operation in 1979) in Higashi Hiroshima. Mitutoyo-brand products delivered through leading-edge technologies and facilities are renowned throughout the world as premier products, promoting a sense of confidence in every customer.



Shiwa Production Department



Kochi Mitutoyo Onomi Plant

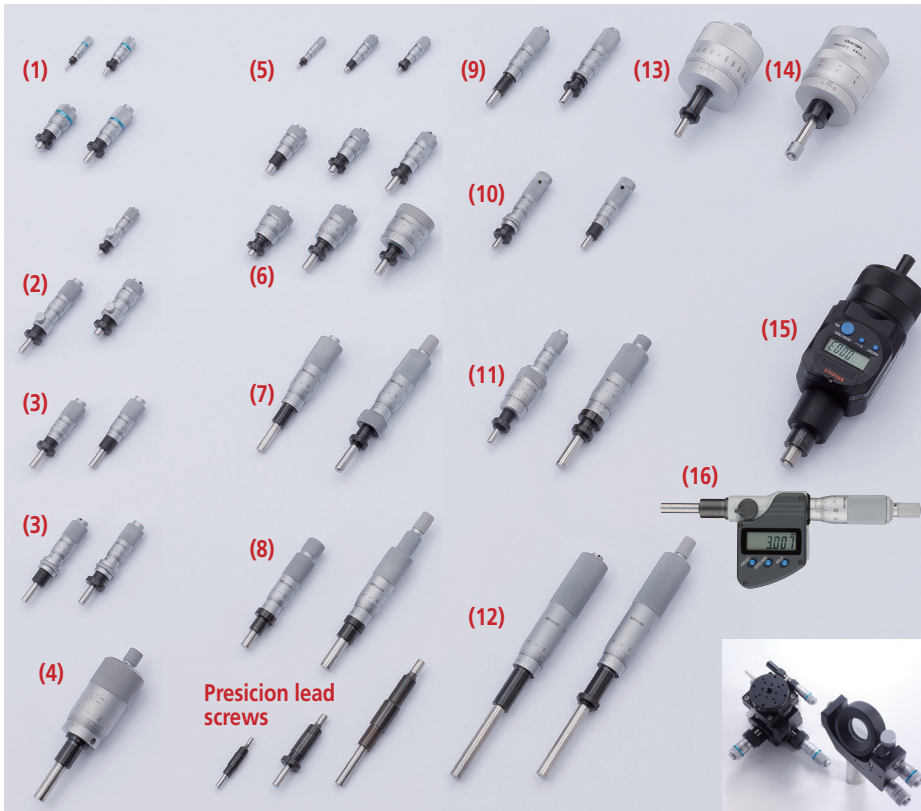

Precision lead screws

Range	Main feature of head	Series	Page
0.02 in / 1 mm	Differential Screw Thread Translator (Extra-Fine Feed) Type	110	6
0.05 in / 2.5 mm	Differential Screw Thread Translator (Extra-Fine Feed) Type (11)		6
0.2 in / 5 mm	Fine Spindle Feed of 0.1 mm/rev (1)	148	12
	Small/Ultra-small Type (5)		7
0.25 in / 6.5 mm	Locking-screw Type (2)	152	11
	Fine Spindle Feed of 0.1 mm/rev (1)		12
	Fine Spindle Feed of 0.25 mm/rev (5)		13
	Small/Ultra-small Type (6)		7
10 mm	Short Thimble with Multiple Diameter Options (6)	148	8
	Large Thimble Type (13)		17
0.5 in / 13 mm	Locking-screw Type (2)	110	11
	Fine Spindle Feed of 0.25 mm/rev (11)		13
	Differential Screw Thread Translator (Extra-Fine Feed) Type (6)	148	6
	Short Thimble with Multiple Diameter Options (3)		8
	Small Standard Type (10)		9
0.5 in / 15 mm	Small Thimble Diameter Standard Type (8)	153	8
	Non-rotating Spindle Type (4)		16
	Quick Spindle Feed of 1 mm/rev (9)		16
	Small Standard Type with Carbide-tipped Spindle (16)		13
1 in / 25 mm	Clear digital display, Non-rotating spindle and IP 65 rated version (8)	350	4 to 5
	Clear digital display, Non-rotating spindle (8)		4 to 5
	Non-rotating Spindle Type (8)	152	16
	Quick Spindle Feed of 1 mm/rev (14)		17
	Large Thimble Type (153)	153	17
	XY-Stage Type (153)		18
	High Accuracy and Resolution (250)	151	18
	Digit Counter Type (7)		14
Medium-sized Standard Type (151)	164	15	
Medium-sized Standard Type with 8 mm Diameter Spindle (15)		15	
2 in / 50 mm	Digimatic (152)	164	4 to 5
	Large Thimble Type (197)		17
	Long Stroke Non-rotating Spindle (151)		18
60 - 75 mm	Medium-sized Standard Type with 8 mm Diameter Spindle (12)	7	15
	Micro Jack		19

High Resolution models highlighted

Precision adjustment of mirror in holder

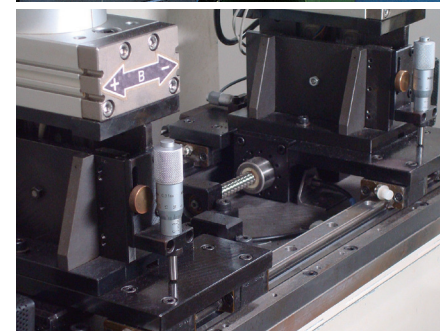
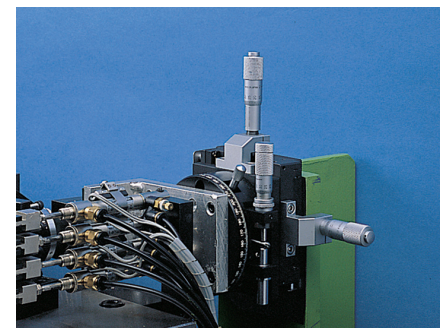
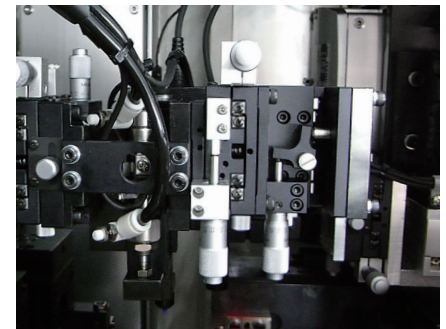
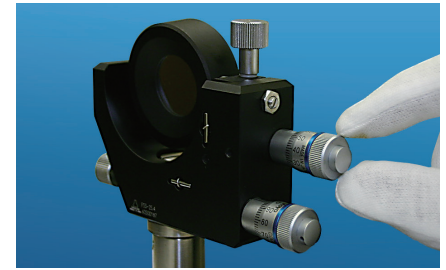



SERIES 164, 350

- Easy-to-read digital display.
- All models support data output.
- Origin point setting.
- Zero setting.
- Auto power ON/OFF.
- Error alarm.



Rotatable display

164-163



350-281-30 (IP65)

Inch / Metric		Order No.	Range (in)	Resolution	Graduation	Stem	Stem dia. (in)	Spindle end	Graduation features	Accuracy (in)
		164-164	0 - 2		—	Plain	0.709	Flat (carbide tip)	—	±0.00015
		350-351-30	0 - 1	0.00005 in/ 0.001 mm	0.001 in/ 0.01 mm	W/clamp nut	0.375	Spherical (SR4) (carbide tip)	Standard	±0.0001
		350-352-30				Plain				
		350-353-30				W/clamp nut				
		350-354-30				Plain				
		350-357-30				W/clamp nut				
		350-381-30*1				Plain				
		350-382-30*1				W/clamp nut				
		350-383-30*1				Plain				
		350-384-30*1				W/clamp nut				
		350-361-30*1				Plain				

Metric		Order No.	Range (mm)	Resolution (mm)	Graduation (mm)	Stem	Stem dia. (mm)	Spindle end	Graduation features	Accuracy (µm)
		164-163	0 - 50		—	Plain	18	Flat (carbide tip)	—	±3
		350-251-30	0 - 25	0.001	0.01	W/clamp nut	10	Spherical (SR4) (carbide tip)	Standard	±2
		350-252-30				Plain				
		350-253-30				W/clamp nut				
		350-254-30				Plain				
		350-281-30*1				W/clamp nut				
		350-282-30*1				Plain				
		350-283-30*1				W/clamp nut				
		350-284-30*1				Plain				
		350-261-30*1				Flat				
		350-271-30*1				Spherical (SR4) (carbide tip)				
		350-272-30	W/clamp nut							
		350-273-30*1	Plain							
		350-274-30	W/clamp nut							

- Power source for **series 350**: SR44 battery (1 pc.), **938882** included as standard
- Power source for **series 164**: SR44 battery (2 pcs.), **938882** included as standard
- Battery life: Approx. 2.4 years under normal use (for **350-XXX**)
Approx. 1.8 years under normal use (for **164-163, 164**)
- Satin-chrome plated
- *1 IP65 dust/water protection type.

Plain Stem



Plain stem

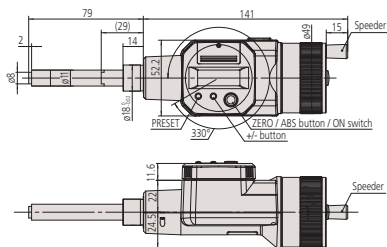

164-163 Rotatable display Mass: 490 g
() : with spindle fully retracted.

Plain Stem

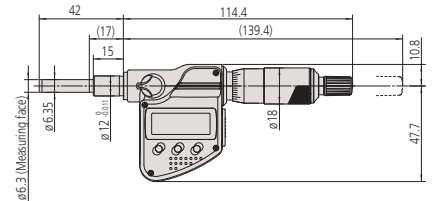

350-281-30
(Stem dia. 12 mm, water-proof type) Mass: 230 g

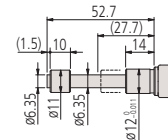

Equipped with a non-rotating device
350-261-30
(Stem dia. 12 mm, water-proof type)
Mass: 235 g

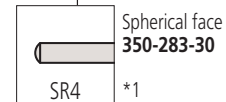

*1 Other dimensions are the same as **350-281-30**.
() : with spindle fully retracted.

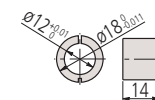

Bushings (standard accessory)
350-261-30

Plain Stem

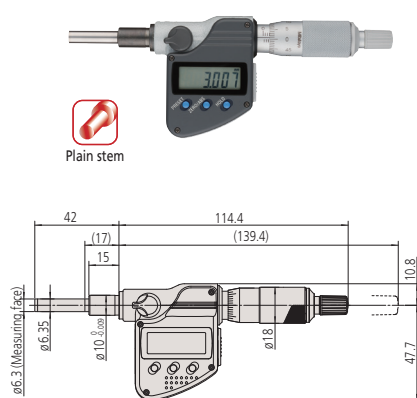

350-251-30
(Stem dia. 10 mm, for general use) Mass: 230 g

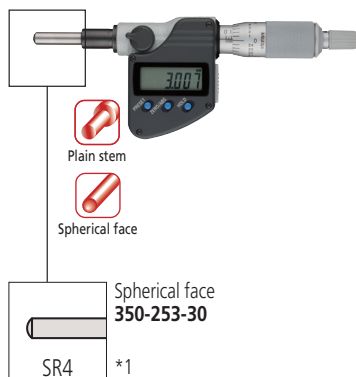

*1 Other dimensions are the same as **350-251-30**.
(): with spindle fully retracted.

Stem Locknut

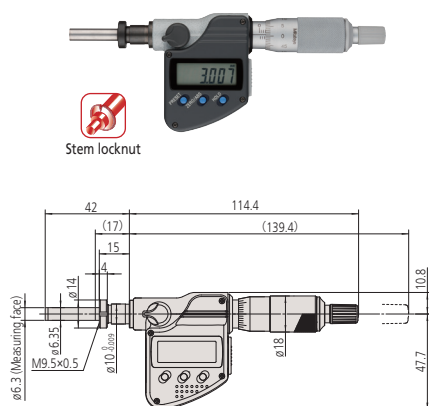

• Fixture thickness: 11.5 mm
350-252-30
(Stem dia. 10 mm, for general use) Mass: 230 g

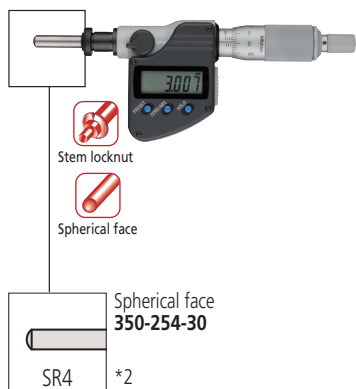

*2 Other dimensions are the same as **350-252-30**.
(): with spindle fully retracted.

Optional Accessories

Order No.	Type	Description
264-020	—	USB Input Tool Series USB Keyboard Signal Conversion Type IT-020U
05CZA662	B	Connection cable (1 m): for series 350 (IP65)
05CZA663	B	Connection cable (2 m): for series 350 (IP65)
959149	C	Connection cable for series 164 (1 m)
959150	C	Connection cable for series 164 (2 m)
06AFM380B	B	USB Input Tool Direct for series 350 (IP65) (2 m)
06AFM380C	C	USB Input Tool Direct for series 164 (2 m)
02AZD790B	B	Connection cable for U-WAVE-T (160 mm): for series 350 (IP65)
02AZE140B	B	Connection cable for U-WAVE-T For foot switch: for series 350 (IP65)
02AZD790C	C	Connection cable for U-WAVE-T (160 mm): for series 164
02AZE140C	C	Connection cable for U-WAVE-T For foot switch: for series 164
264-622	IP67	U-WAVE-TM
264-623	Buzzer	U-WAVE-TM
264-626	IP67	U-WAVE-TMB
264-627	Buzzer	U-WAVE-TMB
02AZF310	IP67	Connecting unit for U-WAVE-TM/TMB*

* Cannot be used with **164-163** and **164-164**



SERIES 110 — Differential Screw Thread Translator (Extra-Fine Feed) Type

- Differential movements of spindle threads and units allow extra-fine spindle feeding (down to 0.025 mm/rev, .001 in/rev), resulting in high-resolution measurements.
- Measuring face: Material/Carbide tip (**110-502-10/504-10**) are alloy tool steel, Hardness/90 HRC or more (Only **110-502-10/504-10** are 60 HRC or more), Lapped.
- Satin-chrome plated.

- Differential movement mechanism with double spindle.
- Non-rotating spindle.
- Fixture thickness: 9.5 mm



Stem locknut

Equipped with Vernier scale

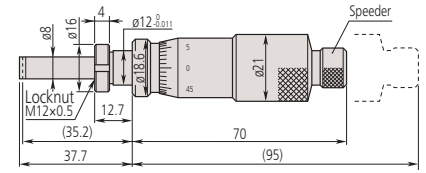

110-101
110-102 Equipped with Vernier scale

- Differential movement mechanism with double spindle.
- Non-rotating spindle.
- Fixture thickness: 9.5 mm



Stem locknut

Equipped with Vernier scale

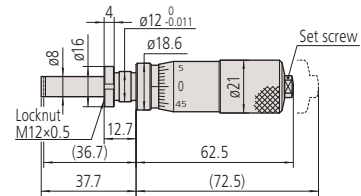

110-105-10
110-106-10 Equipped with Vernier scale

- Dual thimble
- Fixture thickness: 11.5 mm



Stem locknut



Spherical face

Inch					
Order No.	Range (in)	Graduation (in)	Graduation features		
110-111	0 - 0.05	0.00002	Standard		
110-112		0.000005	Fine		
110-115-10	0 - 0.02	0.00002	Standard		
110-116-10		0.000005	Fine		
110-117-10		0.00002	Standard		
110-118-10		0.000005	Fine		
110-504-10	Thimble (fine)	0 - 0.006	Thimble (fine)	0.00002	Dual scales; 0.2 mm/0.006 in fine-feed range
	Thimble (coarse)	0 - 0.5	Thimble (coarse)	0.001	

Order No.	Stem dia. (in)	Stem	Spindle end	Accuracy*1 (in)
110-111	0.5	W/clamp nut	Flat (carbide tip)	±0.00025/±0.00006
110-112				
110-115-10			Spherical (SR10) (carbide tip)	±0.00015/±0.00006
110-116-10				
110-117-10				
110-118-10				
110-504-10	0.375	Spherical	±0.00015/±0.00006	

Metric					
Order No.	Range (mm)	Graduation (mm)	Graduation features		
110-101	0 - 2.5	0.001	Standard		
110-102		0.0001	Fine		
110-105-10	0 - 1	0.001	Standard		
110-106-10		0.0001	Fine		
110-107-10		0.001	Standard		
110-108-10		0.0001	Fine		
110-502-10	Thimble (fine)	0 - 0.2	Thimble (fine)	0.0005	Dual scales; 0.2 mm fine-feed range
	Thimble (coarse)	0 - 13	Thimble (coarse)	0.01	

Order No.	Stem dia. (mm)	Stem	Spindle end	Accuracy*1 (µm)
110-101	12	W/clamp nut	Flat (carbide tip)	±5/±1.5
110-102				
110-105-10			Spherical (SR10) (carbide tip)	±3/±1.5
110-106-10				
110-107-10				
110-108-10				
110-502-10	9.5	Spherical	±3/±1.5	

*1 Wide range/narrow range (Narrow range: 1 rev)

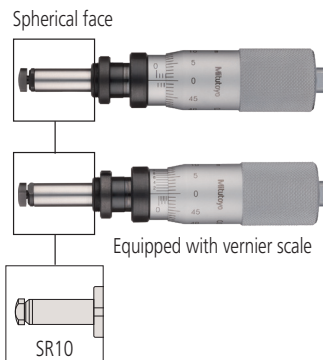

110-107-10
110-108-10 Equipped with Vernier scale

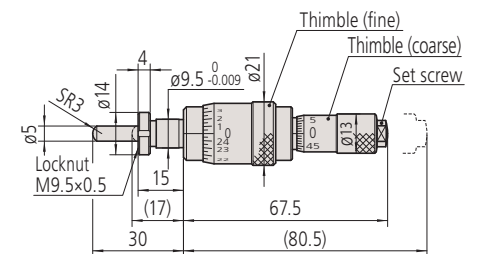

110-502-10



SERIES 148 — Small/Ultra-small Type

- Miniature and light-weight micrometer heads for easier incorporation into machines, jigs and fixtures.

Inch						
Order No.	Range (in)	Stem dia. (in)	Stem	Spindle end	Type	Accuracy (in)
148-217	0 - 0.2	0.156	Plain	Spherical (SR1.5)	Standard	±0.00025
148-218			W/clamp nut			
148-202-10	0 - 0.25	0.25	Plain	Flat		
148-204-10			W/clamp nut			
148-206-10			Plain	Spherical (SR3)		
148-208-10			W/clamp nut			
148-210-10	Reverse reading	Plain	Flat			
148-212-10		W/clamp nut				

Metric						
Order No.	Range (mm)	Stem dia. (mm)	Stem	Spindle end	Type	Accuracy (µm)
148-215	0 - 5	3.5	Plain	Spherical (SR1.5)	Standard	±5
148-216			W/clamp nut			
148-201-10	0 - 6.5	6	Plain	Flat		
148-203-10			W/clamp nut			
148-205-10			Plain	Spherical (SR3)		
148-207-10			W/clamp nut			
148-209-10	Reverse reading	Plain	Flat			
148-211-10		W/clamp nut				

- Graduation: 0.02 mm (148-215, 148-216), 0.01 mm or 0.001 in
- Measuring face: Material/Alloy tool steel, Hardness/60 HRC or more, Lapped
- Satin-chrome plated

Stem Locknut

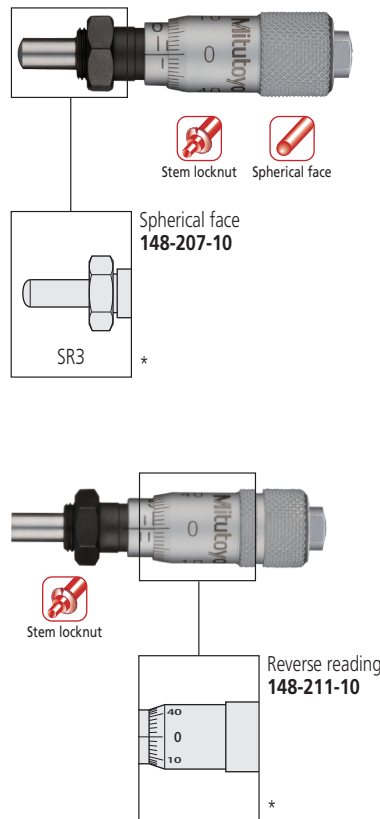
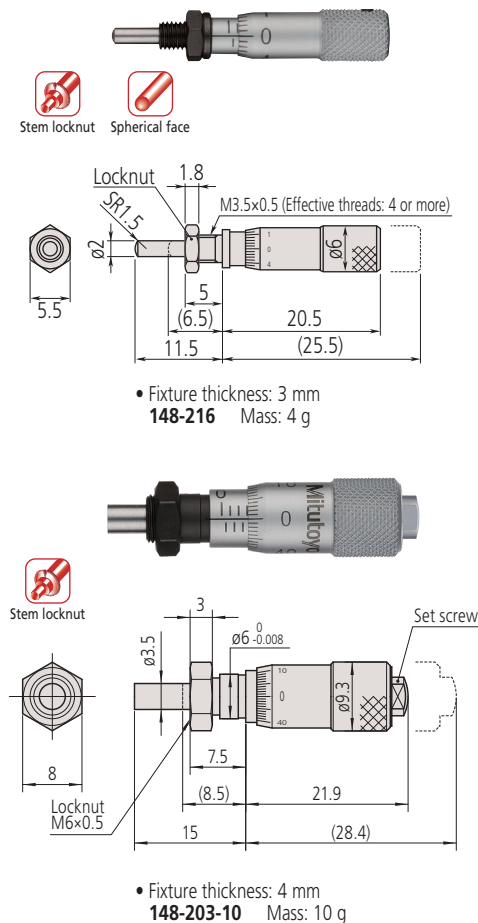

* Other dimensions are the same as 148-203-10.
() : with spindle fully retracted.

Plain Stem

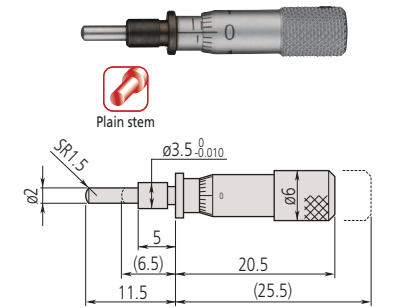

148-215 Mass: 4 g

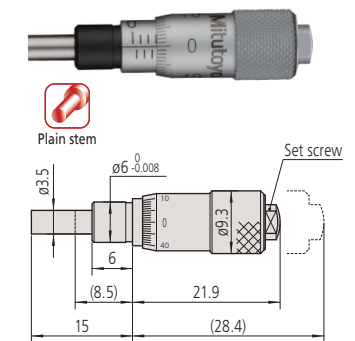
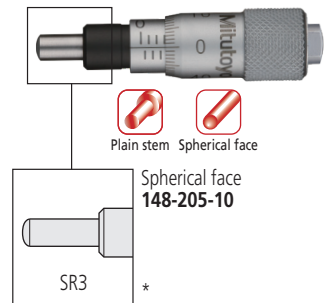

148-201-10 Mass: 10 g

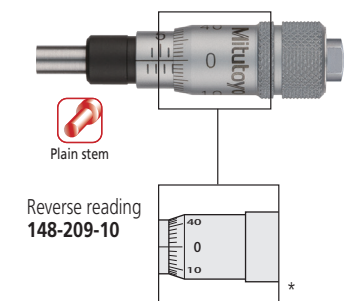

* Other dimensions are the same as 148-201-10.
() : with spindle fully retracted.



SERIES 148 — Short Thimble with Multiple Diameter Options

- Short body design maintains measuring range for limited space applications.
- Three types of thimble diameters can be selected depending on applications.

Inch							
Order No.	Range (in)	Graduation (in)	Accuracy (in)	Stem dia. (in)	Stem	Spindle end	Thimble dia. (in)
148-351-10	0 - 0.25	0.001	±0.0001	0.375	Plain	Flat	0.59
148-352-10					W/clamp nut		
148-353-10					Plain		
148-354-10	W/clamp nut				0.79		
148-357-10	Plain						
148-358-10	W/clamp nut						
148-359-10	0 - 0.5	0.001	±0.0001	0.375	Plain	Flat	0.59
148-360-10					W/clamp nut		0.79

- Spindle pitch: 0.025 in
- Measuring face: Material/Alloy tool steel, Hardness/60 HRC or more, Lapped
- Satin-chrome plated

Metric							
Order No.	Range (mm)	Graduation (mm)	Accuracy (µm)	Stem dia. (mm)	Stem	Spindle end	Thimble dia. (mm)
148-301-10	0 - 6.5	0.01	±2	9.5	Plain	Flat	15
148-302-10					W/clamp nut		
148-303-10					Plain		
148-304-10					W/clamp nut	Spherical (SR4)	15
148-313-10					Plain		
148-314-10					W/clamp nut		
148-307-10	0 - 13	0.01	±2	9.5	Plain	Flat	15
148-308-10					W/clamp nut		
148-309-10					Plain		
148-310-10					W/clamp nut		
148-311-10					Plain		
148-312-10					W/clamp nut		29

- Spindle pitch: 0.5 mm
- Measuring face: Material/Alloy tool steel, Hardness/60 HRC or more, Lapped
- Satin-chrome plated



Plain Stem

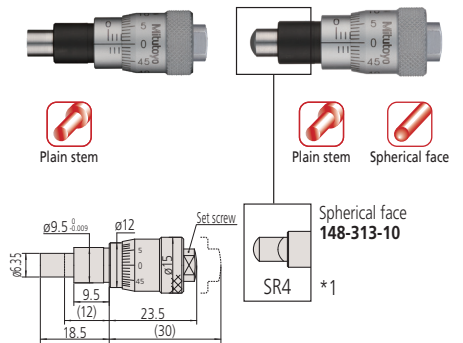

148-301-10
Mass: 26 g
Thimble diameter: 15

*1 Other dimensions are the same as **148-301-10**.

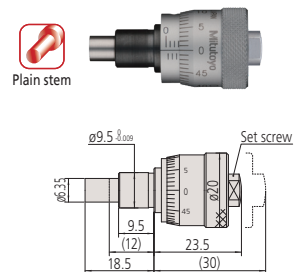

148-303-10
Mass: 39 g
Thimble diameter: 20

Stem Locknut

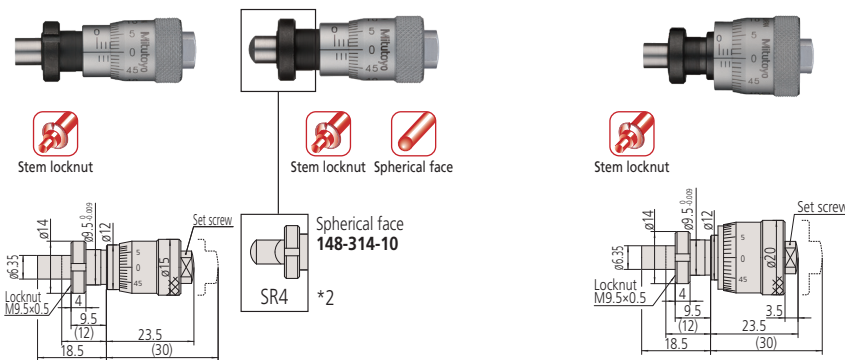

• Fixture thickness: 6 mm
148-302-10
Mass: 26 g
Thimble diameter: 15

• Fixture thickness: 6 mm
148-304-10
Mass: 39 g
Thimble diameter: 20

*2 Other dimensions are the same as **148-302-10**.

(): with spindle fully retracted.



SERIES 148 — Small Standard Type

- Measuring range: 13 mm
- Spindle pitch: .075 in / 0.5 mm
- Measuring face: Material/Alloy tool steel, Hardness/60 HRC or more, Lapped.
- Satin-chrome plated.

Inch								
Order No.	Range (in)	Graduation (in)	Accuracy (in)	Stem dia. (in)	Stem	Spindle end	Graduation features	
148-112-10	0 - 0.5	0.001	±0.0001	0.375	Plain	Flat	Standard	
148-111-10					W/clamp nut			
148-123-10					Plain*			
148-122-10					W/clamp nut*			
148-811-10					Plain			
148-812-10					W/clamp nut			
148-813-10					Plain*	Spherical (SR4)		
148-814-10					W/clamp nut*			
148-831-10					Plain			
148-832-10					W/clamp nut			Flat
148-833-10					Plain*			
148-834-10					W/clamp nut*			

Metric								
Order No.	Range (mm)	Graduation (mm)	Accuracy (µm)	Stem dia. (mm)	Stem	Spindle end	Graduation features	
148-104-10	0 - 13	0.01	±2	9.5	Plain	Flat	Standard	
148-103-10					W/clamp nut			
148-121-10					Plain*			
148-120-10					W/clamp nut*			
148-801-10					Plain			
148-802-10					W/clamp nut			
148-803-10					Plain*	Spherical (SR4)		
148-804-10					W/clamp nut*			
148-821-10					Plain			
148-822-10					W/clamp nut			Flat
148-823-10					Plain*			
148-824-10					W/clamp nut*			

* With spindle lock

Plain Stem

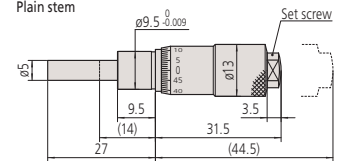

148-104-10

Plain Stem and Spindle Lock

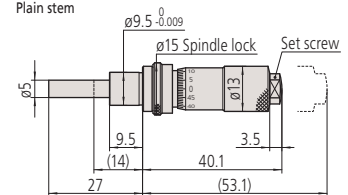

148-121-10

Stem Locknut and Spindle Lock

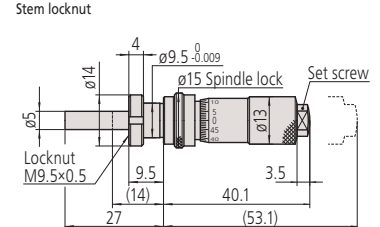

- Fixture thickness: 6 mm
- 148-120-10

Stem Locknut

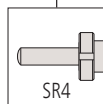
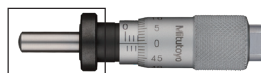

Spherical face
148-802-10

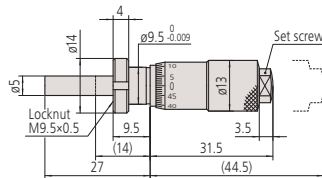



SERIES 148 — Small Thimble Diameter Standard Type

- Measuring range: .5 in or 13 mm
- The thimble can be set to zero at any position by loosening the set screw.
- Measuring face: Material/Alloy tool steel, Hardness/60 HRC or more, Lapped.
- Satin-chrome plated.

Inch								
Order No.	Range (in)	Graduation (in)	Accuracy (in)	Stem dia. (in)	Stem	Spindle end	Special features	
148-501	0 - 0.5	0.001	±0.0001	0.375	Plain	Flat	Standard	
148-507					W/clamp nut			
148-505					Plain* ¹			
148-502					W/clamp nut* ¹			
148-851					Plain	Spherical (SR4)		
148-852					W/clamp nut* ¹			
148-861					Plain	Flat		Reverse reading
148-862					W/clamp nut* ¹			

Metric								
Order No.	Range (mm)	Graduation (mm)	Accuracy (µm)	Stem dia. (mm)	Stem	Spindle end	Special features	
148-503	0 - 13	0.01	±2	9.5	Plain	Flat	Standard	
148-508					W/clamp nut			
148-506					Plain* ¹			
148-504					W/clamp nut* ¹			
148-853					Plain	Spherical (SR4)		
148-854					W/clamp nut* ¹			
148-863					Plain	Flat		Reverse reading
148-864					W/clamp nut* ¹			
148-858* ²					W/clamp nut	Spherical (SR4)		Standard
148-866* ²					Plain* ¹			
148-856* ²					Plain* ¹	Spherical (SR4)		Standard
148-868* ²					W/clamp nut			

*1 With spindle lock

*2 Made-to-order models

Plain Stem



Plain stem

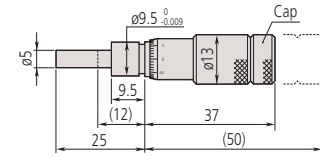

148-503

Stem Locknut and Spindle Lock



Stem locknut

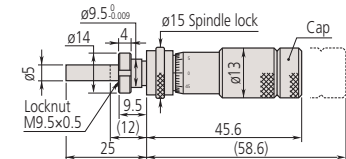

- Fixture thickness: 6 mm
- 148-504



SERIES 148 — Locking-screw Type

- This model with enhanced clamping force created by a locking screw can be reliably used on positioning equipment or instruments constantly exposed to vibration.
- Position of the locking screw is the same as the sleeve index line.
- Measuring face: Material/Alloy tool steel, Hardness/60 HRC or more, Lapped.
- Satin-chrome plated.

Inch							
Order No.	Range (in)	Graduation (in)	Stem dia. (in)	Stem	Spindle end	Graduation features	Accuracy (in)
148-230-10	0 - 0.25	0.001	0.25	Plain	Flat	Standard	±0.00025
148-231-10				W/clamp nut			
148-232-10				Plain	Spherical (SR3)		
148-233-10	W/clamp nut						
148-160-10	0 - 0.5	0.001	0.375	Plain	Flat	Standard	±0.0001
148-161-10				W/clamp nut			
148-162-10				Plain	Spherical (SR4)		
148-163-10	W/clamp nut						
148-326-10	0 - 0.25	0.001	0.375	Plain	Flat	Standard	±0.0001
148-327-10				W/clamp nut			
148-328-10				Plain	Spherical (SR4)		
148-329-10	W/clamp nut						

Metric							
Order No.	Range (mm)	Graduation (mm)	Stem dia. (mm)	Stem	Spindle end	Graduation features	Accuracy (µm)
148-220-10	0 - 6.5	0.01	6	Plain	Flat	Standard	±5
148-221-10				W/clamp nut			
148-222-10				Plain	Spherical (SR3)		
148-223-10	W/clamp nut						
148-150-10	0 - 13	0.01	9.5	Plain	Flat	Standard	±2
148-151-10				W/clamp nut			
148-152-10				Plain	Spherical (SR4)		
148-153-10	W/clamp nut						
148-316-10	0 - 6.5	0.01	9.5	Plain	Flat	Standard	±2
148-317-10				W/clamp nut			
148-318-10				Plain	Spherical (SR4)		
148-319-10	W/clamp nut						

Secure spindle

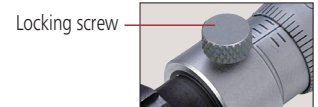

Stem Locknut

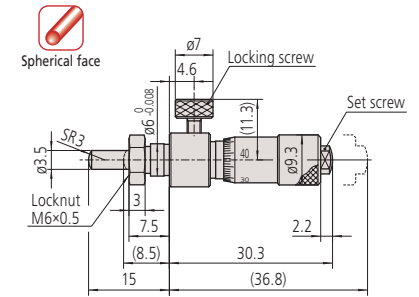
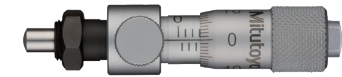

Spherical face (SR3) • Fixture thickness: 4 mm
148-223-10

Stem Locknut

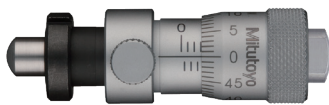

Spherical face

Spherical surface (SR4) • Fixture thickness: 6 mm
148-319-10

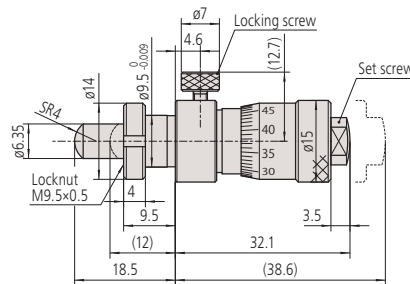

Plain Stem

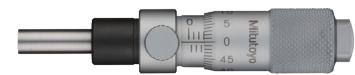

Plain stem

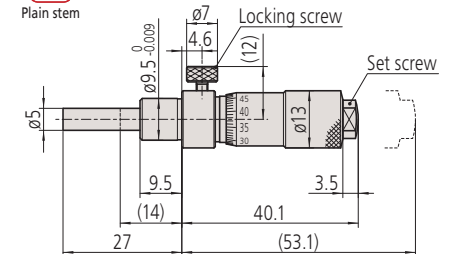

148-150-10

20% OFF

SERIES 148 — Fine Spindle Feed of 0.1 mm/rev

- Fine spindle feeding of just 0.1 mm/rev (one fifth compared with standard model). Suitable for extra-fine adjustment and positioning.
- External dimensions are compatible with standard 0.5 mm pitch heads.
- Suitable for the fine feeding of precision stages on semiconductor equipment and optical-axis alignment device.
- Measuring face: Material/Alloy tool steel, Hardness/60 HRC or more, Lapped.
- Satin-chrome plated.

Metric								
Order No.	Range (mm)	Graduation (mm)	Stem dia. (mm)	Stem	Spindle end	Spindle pitch (mm)	Maximum permissible error J_{MPE} (μ m)	Special features
148-142-10	0 - 6.5	0.002	9.5	Plain	Spherical (SR4)	0.1	± 2	Thicker & shorter thimble
148-143-10				W/clamp nut				
148-342-10				Plain				
148-343-10			W/clamp nut					
148-242-10			Plain	6				
148-243-10	W/clamp nut							
148-244	0 - 5	0.004	3.5	Plain	Spherical (SR1.5)	± 5	Small thimble diameter	
148-245				W/clamp nut				

Stem Locknut

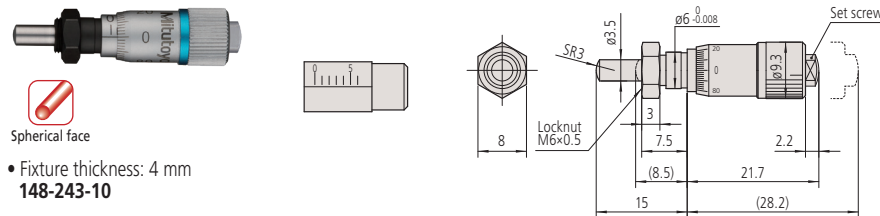
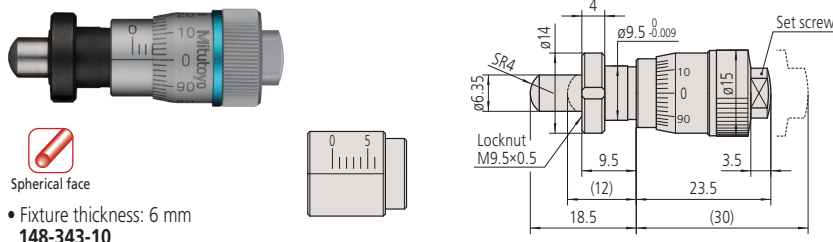
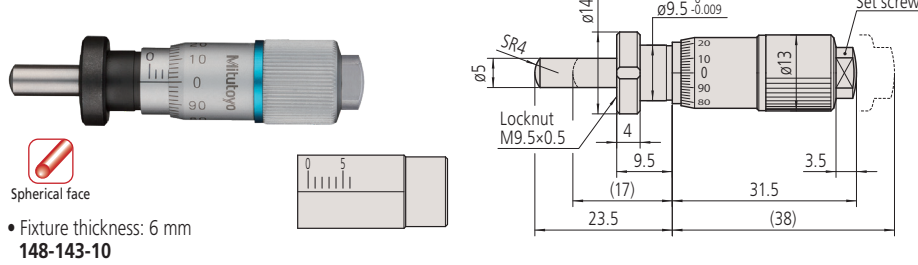

Plain Stem

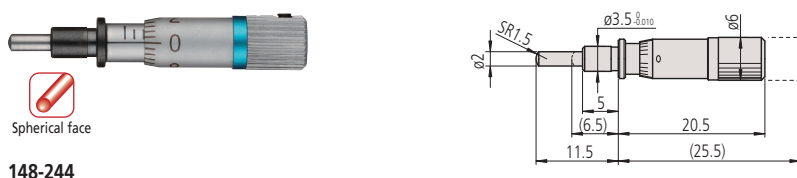

Spindle Pitch

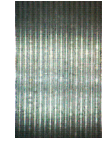

Pitch=0.1 mm

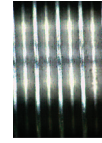

Pitch=0.5 mm

Typical Applications

- Semiconductor-wafer positioning machinery and optical component alignment units, etc.

- Precision X-Y table positioning

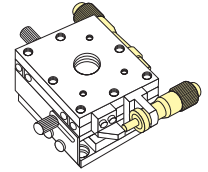

- Precision adjustment of mirror in holder

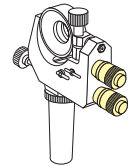

Precision adjustment of mirror in holder

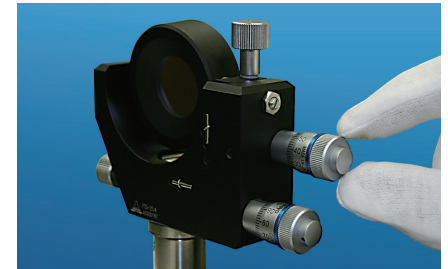

Comparison of Mounting Dimensions Between a Fine-pitch Head and a Standard-pitch Head at the Mid-range Travel Position.

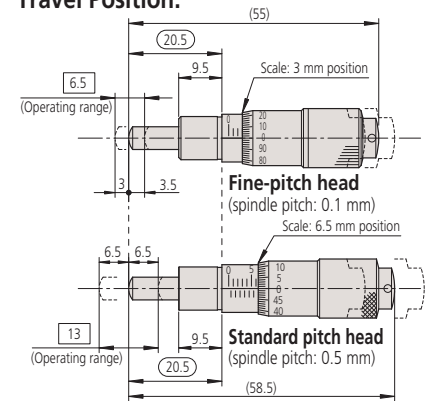

Note: While the fine-pitch micrometer head has a measuring range of 6.5 mm, the standard head has a larger range of 13 mm. When replacing a standard head, the fine-pitch type can use the common range in the middle of the spindle travel. The standard and compact types of fine-pitch head are otherwise completely interchangeable.

20% OFF

SERIES 148 — Fine Spindle Feed of 0.25 mm/rev

- Fine spindle feeding of just 0.25 mm/rev for fine adjustment and positioning.
- Measuring face: Material/Alloy tool steel, Hardness/60 HRC or more, Lapped.
- Satin-chrome plated.

Metric							
Order No.	Range (mm)	Graduation (mm)	Stem dia. (mm)	Stem	Spindle end	Spindle pitch (mm)	Accuracy (µm)
148-132-10	0 - 13	0.01	9.5	Plain	Spherical (SR4)	0.25	±2
148-133-10				W/clamp nut			
148-322-10	0 - 6.5	0.01	9.5	Plain	Spherical (SR4)	0.25	±2
148-323-10				W/clamp nut			

Plain Stem

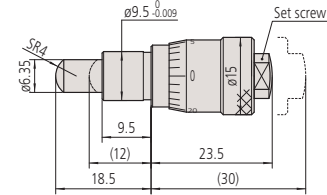

148-322-10

Stem Locknut

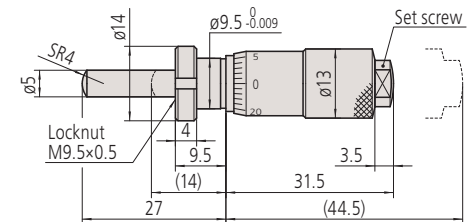

• Fixture thickness: 6 mm
148-133-10

SERIES 149 — Small Standard Type with Carbide-tipped Spindle

20% OFF

- Spindle pitch: 0.5 mm or 0.025 in
- Measuring face: Material/Carbide tip, Hardness/90 HRA or more, Lapped.
- Carbide-tipped spindle provides high abrasion resistance.
- Satin-chrome plated.

Inch							
Order No.	Range (in)	Graduation (in)	Accuracy (in)	Stem dia. (in)	Stem	Spindle end	Graduation features
149-148-10	0 - 0.5	0.001	±0.0001	0.375	Plain	Flat (carbide tip)	Standard
149-147-10					W/clamp nut		
149-185-10*3					Plain*1		
149-182-10					W/clamp nut*1	Spherical (SR4) (carbide tip)	
149-811-10					Plain		
149-812-10					W/clamp nut	Flat (carbide tip)	
149-831-10*2	Plain	Reverse reading					
149-832-10*2	W/clamp nut	Standard					
149-181*2	Plain*1						

Metric							
Order No.	Range (mm)	Graduation (mm)	Accuracy (µm)	Stem dia. (mm)	Stem	Spindle end	Graduation features
149-132-10	0 - 15	0.01	±2	9.5	Plain	Flat (carbide tip)	Standard
149-131-10					W/clamp nut		
149-183-10					Plain*1		
149-184-10					W/clamp nut*1	Spherical (SR4) (carbide tip)	
149-801-10					Plain		
149-802-10					W/clamp nut	Flat (carbide tip)	
149-821-10	Plain	Reverse reading					
149-822-10	W/clamp nut	Spherical (SR4) (carbide tip)					
149-803-10*2	Plain*1		Standard				
149-804-10*2	W/clamp nut*1	Flat (carbide tip)					
149-823-10*2	Plain*1		Reverse reading				
149-824-10*2	W/clamp nut*1						

*1 With spindle lock *2 Made-to-order models *3 W/ratchet (149-181) is available

Plain Stem

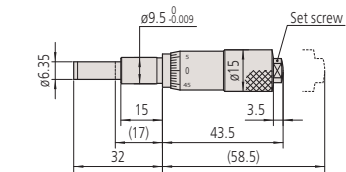

149-132-10

Plain Stem and Spindle Lock

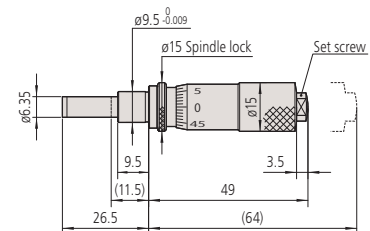

149-183-10

Stem Locknut

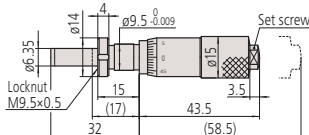

• Fixture thickness: 11.5 mm
149-131-10

Stem Locknut and Spindle Lock

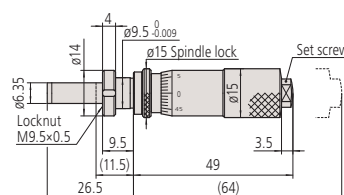

• Fixture thickness: 6 mm
149-184-10



SERIES 150 — Medium-sized Standard Type

- Measuring range: 1 in or 25 mm
- Spindle pitch: 0.025 in or 0.5 mm
- Satin-chrome plated.
- Measuring face: Material/Carbide tip (only long spindle model is alloy tool steel), Hardness/90 HRA or more (only long spindle model is 60 HRC or more), Lapped.

Inch							
Order No.	Range (in)	Graduation (in)	Accuracy (in)	Stem dia. (in)	Stem	Spindle end	Special features
150-208	0 - 1	0.001	±0.0001	0.375	Plain	Flat (carbide tip)	Standard
150-207					W/clamp nut		
150-213					Plain*1		
150-214					W/clamp nut*1	Spherical (SR4) (carbide tip)	
150-811					Plain		
150-812					W/clamp nut		
150-831		Plain	Reverse graduation				
150-832		W/clamp nut					
150-206		Plain		Flat (carbide tip)			
150-205		W/clamp nut					
150-215		Plain*1					
150-216		W/clamp nut*1	W/Vernier (0.0001 in)				
150-198-10	0.001	0.001		Plain	W/O ratchet stop		
150-197-10				W/clamp nut			
150-217*2			Plain*1				
150-218*2	W/clamp nut*1						

Metric							
Order No.	Range (mm)	Graduation (mm)	Accuracy (µm)	Stem dia. (mm)	Stem	Spindle end	Special features
150-192	0 - 25	0.01	±2	10	Plain	Flat (carbide tip)	Standard
150-191					W/clamp nut		
150-209					Plain*1		
150-210					W/clamp nut*1	Spherical (SR4) (carbide tip)	
150-801					Plain		
150-802					W/clamp nut		
150-821		W/clamp nut	Reverse reading				
150-822		Plain					
150-190		W/clamp nut		Flat (carbide tip)			
150-189		Plain					
150-183*2		W/clamp nut	W/Vernier (0.001 mm)				
150-184		Plain*1					
150-196-10	W/clamp nut*1						
150-195-10	0.01	0.01	±2	10	W/clamp nut	W/o ratchet stop	
150-211-10					Plain*1		
150-212-10					W/clamp nut*1		
150-803*2					Plain*1	Spherical (SR4) (carbide tip)	
150-804*2					W/clamp nut*1		
150-823*2					Plain*1		Flat (carbide tip)
150-824*2	W/clamp nut*1						

*1 With spindle lock
*2 Made-to-order models

Stem Locknut

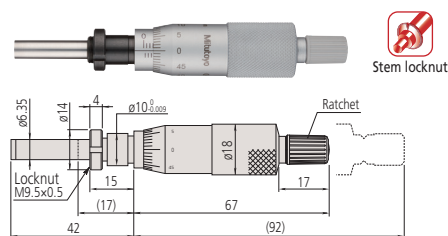

• Fixture thickness: 11.5 mm
150-191

Plain Stem and Spindle Lock

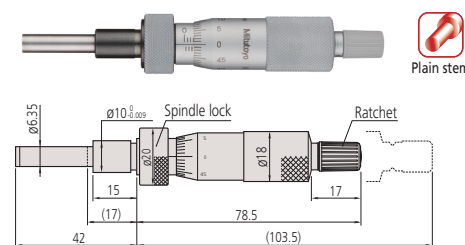

150-209

Plain Stem

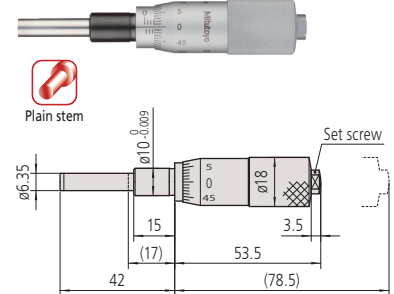

150-196-10

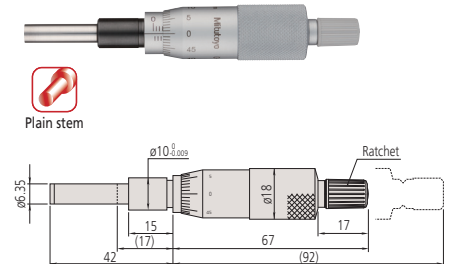

150-192

Stem Locknut and Spindle Lock

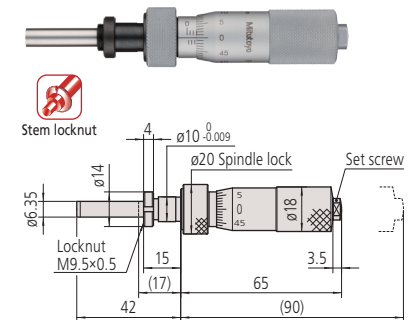

Fixture thickness: 11.5 mm
150-212-10

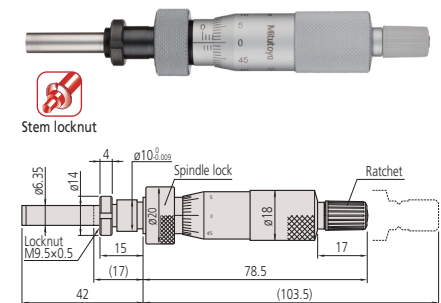

• Fixture thickness: 11.5 mm
150-210



SERIES 151 — Medium-sized Standard Type with 8 mm Diameter Spindle

- Larger spindle (ø8 mm) for heavy-duty applications (normally ø6.35 mm).
- Spindle pitch: 0.025 in or 0.5 mm
- Measuring face: Material/Carbide tip, Hardness/90 HRA or more, Lapped.
- Satin-chrome plated.

Inch									
Order No.	Range (in)	Graduation (in)	Accuracy (in)	Stem dia. (in)	Stem	Spindle end	Special features		
151-240	0 - 1	0.001	±0.0001	0.5	Plain	Flat (carbide tip)	—		
151-239					W/clamp nut				
151-238		Plain			W/Vernier (0.0001 in)				
151-237		W/clamp nut							
151-241-10		0.001			0.001			Plain*1	W/o ratchet stop
151-242-10								W/clamp nut*1	
151-243-10	Plain*1		W/o ratchet stop (0.0001 in)						
151-244-10	W/clamp nut*1								
151-272	0 - 2	±0.0002	Plain	—					
151-271			W/clamp nut						

Metric											
Order No.	Range (mm)	Graduation (mm)	Accuracy (µm)	Stem dia. (mm)	Stem	Spindle end	Special features				
151-224	0 - 25	0.01	±2	12	Plain	Flat (carbide tip)	—				
151-223					W/clamp nut						
151-214		Plain*1			W/Vernier (0.001 mm)						
151-213		W/clamp nut*1									
151-222		Plain			W/o ratchet stop						
151-221		W/clamp nut									
151-212*2	Plain*1										
151-211	W/clamp nut*1										
151-227-10	0 - 50	0.01	±4	12	Plain	Flat (carbide tip)	—				
151-228-10					W/clamp nut						
151-225-10		Plain*1			W/o ratchet stop						
151-226-10		W/clamp nut*1									
151-256		0 - 50			0.01			±4	12	Plain	—
151-255										W/clamp nut	
151-260-10	Plain		W/o ratchet stop								
151-259-10	W/clamp nut										

*1 With spindle lock
*2 Made-to-order models

Plain Stem

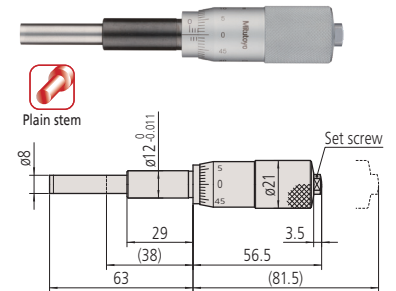

151-227-10

Stem Locknut and Spindle Lock

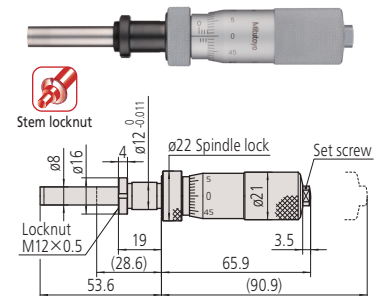

• Fixture thickness: 15.5 mm
151-226-10

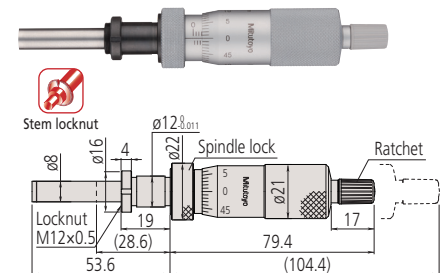

• Fixture thickness: 15.5 mm
151-213

Plain Stem

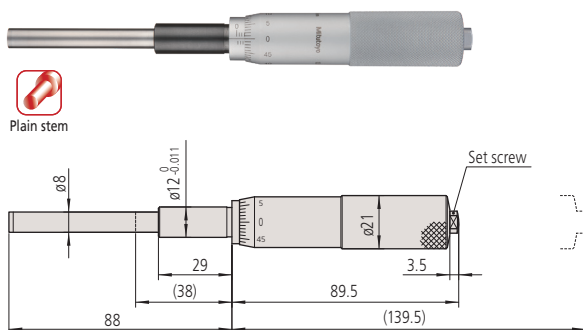

151-260-10

Stem Locknut

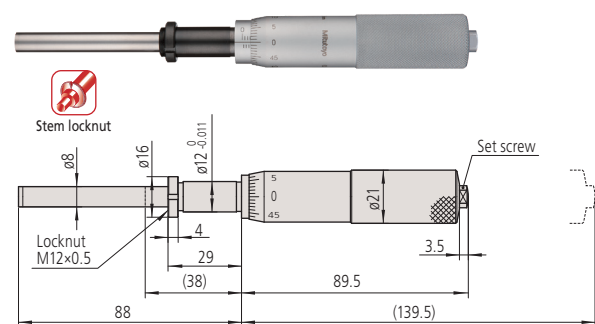

• Fixture thickness: 25.5 mm
151-259-10



SERIES 153 — Non-rotating Spindle Type

- Micrometer head with non-rotating spindle.
- Torsion-free feed reduces workpiece deformation and wear.
- Allows highly accurate positioning.
- Measuring face: Material/Carbide tip, Hardness/90 HRA or more, Lapped.
- Satin-chrome plated.

Inch								
Order No.	Range (in)	Graduation (in)	Graduation features	Stem dia. (in)	Stem	Spindle end	Spindle pitch (in)	Accuracy (in)
153-108	0 - 0.5	0.001	W/vernier (0.0001 in)	0.375	Plain	Flat (carbide tip)	0.025	±0.00015
153-205*1	0 - 1		Standard					
153-206*1		W/vernier (0.0001 in)						
153-207		Standard						
153-208	0 - 1	0.001	W/vernier (0.0001 in)	0.5				

Metric								
Order No.	Range (mm)	Graduation (mm)	Graduation features	Stem dia. (mm)	Stem	Spindle end	Spindle pitch (mm)	Accuracy (µm)
153-101	0 - 15	0.01	Standard	9.5	Plain	Flat (carbide tip)	0.5	±3
153-201*1	0 - 25		W/vernier (0.001 mm)					
153-202*1		Standard						
153-203		W/vernier (0.001 mm)						
153-204	0 - 25	0.01	W/vernier (0.001 mm)	12				

*1 With ratchet stop

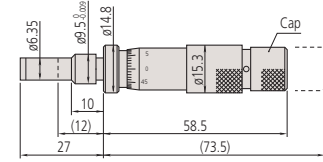

153-101

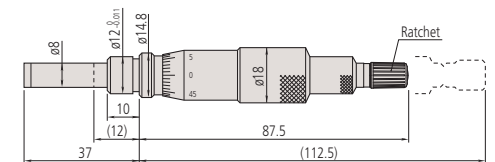

153-201

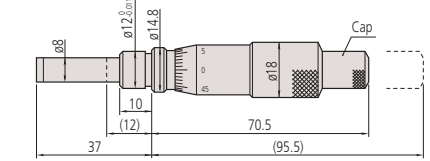

153-203

SERIES 152 — Quick Spindle Feed of 1 mm/rev

- This model enables double-speed spindle feeding of 1 mm/rev (compared with 0.5 mm/rev on typical products) to enable quick positioning.
- It also has a good load-bearing capacity.
- Measuring face: Material/Carbide tip, Hardness/90 HRA or more, Lapped.
- Satin-chrome plated.



Metric							
Order No.	Range (mm)	Graduation (mm)	Stem dia. (mm)	Stem	Spindle end	Spindle pitch (mm)	Accuracy (µm)
152-101	0 - 15	0.01	12	Plain	Flat (carbide tip)	1	±2
152-102	0 - 25						

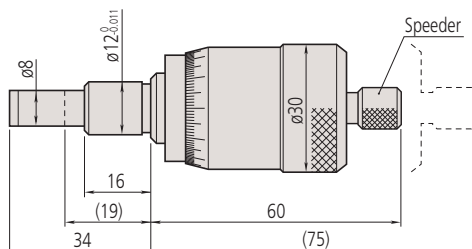

152-101

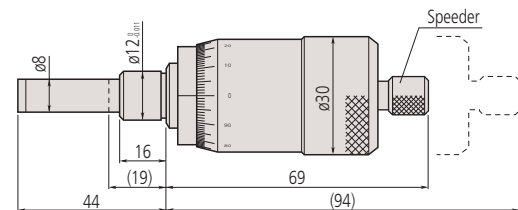

152-102

20% OFF

SERIES 152 — Large Thimble Type

- Large-diameter thimble for fine adjustment and positioning.
- Measuring face: Material/Carbide tip, Hardness/90 HRA or more, Lapped.
- Scale finishing: White anodized aluminum.

Metric								
Order No.	Range (mm)	Graduation (mm)	Graduation features	Stem dia. (mm)	Stem	Spindle end	Spindle pitch (mm)	Accuracy (μm)
152-283	0 - 10	0.002	Standard	12	W/clamp nut	Flat (carbide tip)	0.5	±2
152-332	0 - 25				Plain			±4
152-380	0 - 50		Bidirectional					

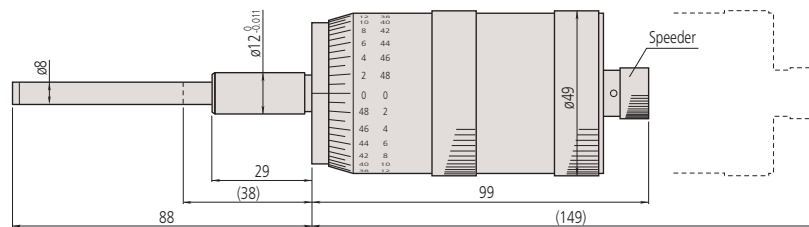

152-380

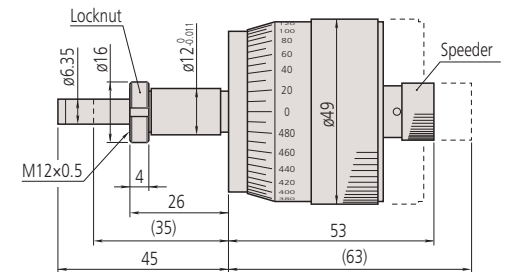

• Fixture thickness: 22.5 mm
152-283

SERIES 152 — XY-Stage Type

- Designed for cross-travel stage translation in the X and Y axes. Bidirectional graduation for easy reading in both directions.
- Measuring face: Material/Carbide tip (152-389/390 are alloy tool steel), Hardness/90 HRA or more (152-389/390 are 60 HRC or more), Lapped.
- Scale finishing: White anodized aluminum.

20% OFF

Metric								
Order No.	Range (mm)	Graduation (mm)	Graduation features	Stem dia. (mm)	Stem	Spindle pitch (mm)	Accuracy (μm)	
152-390	0 - 25	0.005	for X-axis, bidirectional	18	Plain	1	±2	
152-389			for Y-axis, bidirectional					

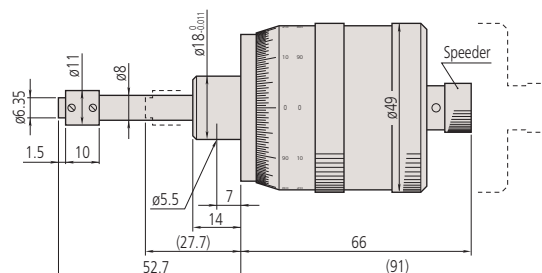

- The thimble can be rotated to a better reading position while maintaining the spindle position.

152-390



152-389



SERIES 197 — Long Stroke Non-rotating Spindle

- Large-thimble micrometer head with non-rotating spindle. Dual-spindle mechanism for quick feeding and bidirectional graduation for easy reading.
- Floating thimble allows easy zero setting at any spindle position.
- Measuring face: Material/Carbide tip, Hardness/90 HRA or more, Lapped.
- Scale finishing: White anodized aluminum.

Inch								
Order No.	Range	Graduation	Graduation features	Stem dia.	Stem	Spindle end	Spindle pitch	Accuracy
197-201	0 - 2 in	0.0002 in	Bidirectional	0.709 in	Plain	Flat (carbide tip)	0.05 in	±0.0001 in

Metric								
Order No.	Range	Graduation	Graduation features	Stem dia.	Stem	Spindle end	Spindle pitch	Accuracy
197-101	0 - 50 mm	0.005 mm	Bidirectional	18 mm	Plain	Flat (carbide tip)	1 mm	±5 μm

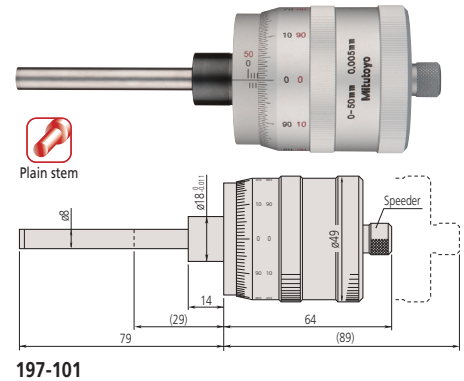

SERIES 153 — High Accuracy and Resolution

- Fine graduation and high accuracy model, suitable for inspection equipment.
- Non-rotating spindle type.
- Measuring face: Material/Carbide tip, Hardness/90 HRA or more, Lapped.
- Scale finishing: White anodized aluminum.



Inch								
Order No.	Range	Graduation	Graduation features	Stem dia.	Stem	Spindle end	Spindle pitch	Accuracy*
153-302	0 - 1 in	10 μinch (Vernier)	Bidirectional	0.75 in	Plain	Flat (carbide tip)	0.025 in	±0.00005 in/ ±0.00003 in

Metric								
Order No.	Range	Graduation	Graduation features	Stem dia.	Stem	Spindle end	Spindle pitch	Accuracy*
153-301	0 - 25 mm	0.0005 mm (Vernier)	Bidirectional	18 mm	Plain	Flat (carbide tip)	0.5 mm	±1/±0.5 μm

* Wide range/narrow range

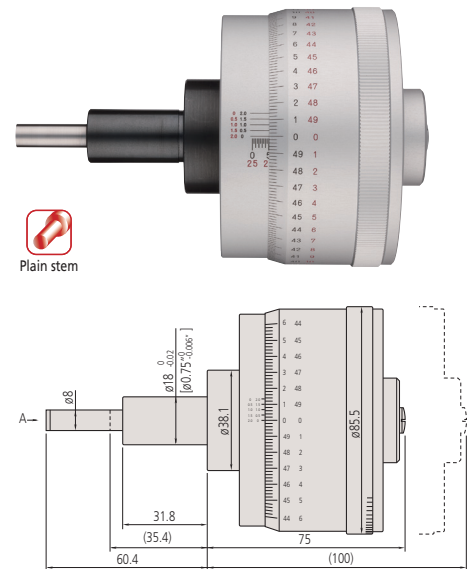

SERIES 250 — Digit Counter Type

- Digit counter for easy reading of spindle movement.
- Measuring face: Material/Carbide tip, Hardness/90 HRA or more, Lapped.
- Satin-chrome plated.



Inch								
Order No.	Range (in)	Graduation (in)	Stem dia. (in)	Stem	Spindle end	Spindle pitch (in)	Graduation features	Accuracy (in)
250-312	0 - 1	0.0001	0.375	Plain	Flat (carbide tip)	0.025	Vernier scale	±.0001

Metric								
Order No.	Range (mm)	Graduation (mm)	Stem dia. (mm)	Stem	Spindle end	Spindle pitch (mm)	Graduation features	Accuracy (μm)
250-301	0 - 25	0.01	10	Plain	Flat (carbide tip)	0.5	—	±2

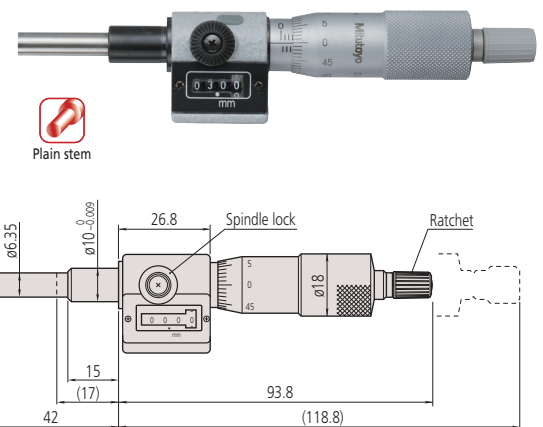

250-301

20% OFF

Micro Jack SERIES 7

- Used for accurate leveling of machines, surface plates, and other precision instruments.
- Zero-setting is possible at any position.
- Easy adjustment under heavy load.
- Measuring face: Material/Alloy tool steel, Hardness/60 HRC or more, Lapped.
- Satin-chrome plated.

Metric				
Order No.	Range (mm)	Graduation (mm)	Remarks (kg)	Handle power at the max. loading (N)
7850	60 - 75	0.01	Max. load: 400	90



7850

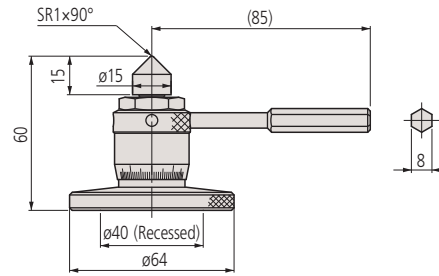

Measurement example



20% OFF

Precision Lead Screws

- Mitutoyo manufactures simple and economical precision lead screws for precise positioning mechanisms and fine-feed mechanisms, in addition to the conventional micrometer heads.
- Mitutoyo also manufactures lead screws with special specifications, such as 0.25 mm pitch as well as those with the standard 0.5 mm feed pitch and with dimensions and forms that meet customer's requirements.
- Measuring face: Material/Alloy tool steel (AS-25 and BS-25 are Carbide tip), Hardness/60

HRC or more (AS-25 and BS-25 are 90 HRA or more), Lapped

- Durability: 100,000 operations are guaranteed (use condition: 4 kg load; 2 kg for AS-6.5 and BS-6.5)

Main applications:

- Precision feed stages
- Fine adjustment of optical elements (mirrors, prisms)
- Fiber optic centering devices
- Various assembly and adjustment jigs

Order No.	Model*	Range (mm)	Feed pitch (mm)	Feed accuracy (μm)	Stem diameter (mm)	Tip diameter (mm)	Tail diameter (mm)	Screw nominal diameter	Sleeve diameter (mm)	Measuring face	Mass (g)
04AZA160	AS-6.5	0 - 6.5	0.5	±5	ø6 ⁰ _{-0.008}	ø3.5	ø3 ⁰ _{-0.01}	M4.5x0.5	ø7	Hardened	10
04AZA161	BS-6.5										11
04AZA162	AS-13	0 - 13	0.5	±2	ø9.5 ⁰ _{-0.009}	ø5	ø5 ⁰ _{-0.012}	M7.35x0.5	ø10.5	Hardened	27
04AZA163	BS-13										30
04AZA164	AS-25	0 - 25	0.5	±2	ø10 ⁰ _{-0.009}	ø6.35	ø6 ⁰ _{-0.015}	M7.35x0.5	ø12	Carbide tip	61
04AZA165	BS-25										64

* AS type: Flat spindle tip without nut, BS type: Spherical spindle tip with nut

Type AS: Plain Stem

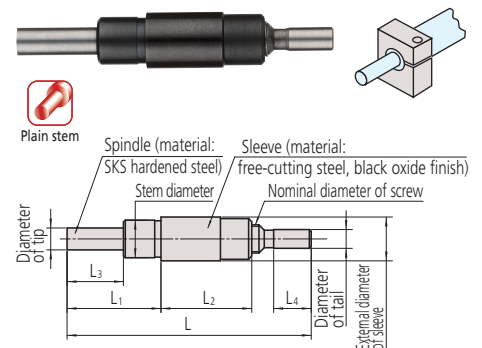

Type BS: Stem with Locknut

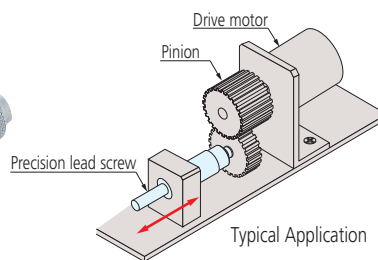
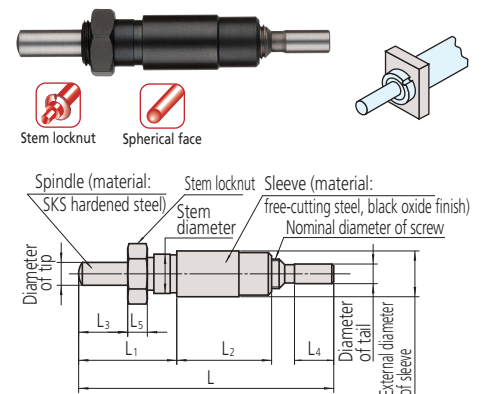

Precision Engineered for OEM Integration

Our micrometer heads are designed specifically for Original Equipment Manufacturers who require consistent, fine adjustment within their instruments, assemblies, and precision mechanisms. Engineered for smooth operation and dependable accuracy, these components integrate seamlessly into OEM designs, enhancing system performance while reducing long-term service demands.

Key Features

- **High-Accuracy Positioning**
Precision-ground spindles and finely graduated scales enable micrometer-level control within integrated systems.
- **Designed for Seamless Integration**
Multiple mounting options, stem styles, and spindle configurations make it easy to incorporate into custom equipment.
- **Reliable, Long-Life Operation**
Robust materials and proven mechanics deliver high repeatability and stable performance in high-duty or continuous-use environments.
- **Smooth, Consistent Adjustment**
Controlled torque and optimized thread geometry ensure uniform feel—ideal for user-facing or automated OEM assemblies.
- **Flexible Customization**
Custom lengths, tip styles, knurling, torque requirements, graduations, and materials available to match specific design needs.

OEM-Focused Benefits

- **Improved System Precision**
Elevate product performance with controlled micro-positioning and tight tolerances.
- **Reduced Integration Engineering Time**
Standardized dimensions and customizable options simplify design and assembly.
- **Enhanced End-User Experience**
Smooth, repeatable operation adds a premium feel to equipment interfaces.
- **Long-Term Reliability**
Durable construction minimizes field service calls, warranty claims, and alignment drift.
- **Cost-Effective Scalability**
Ideal for mid- to high-volume manufacturing with stable supply and consistent quality.

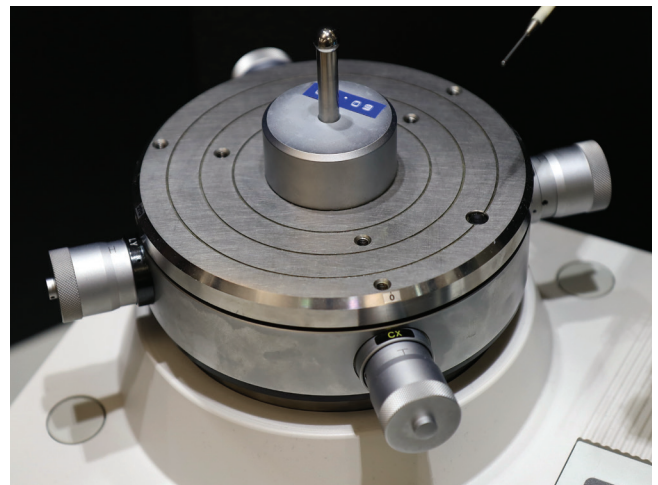
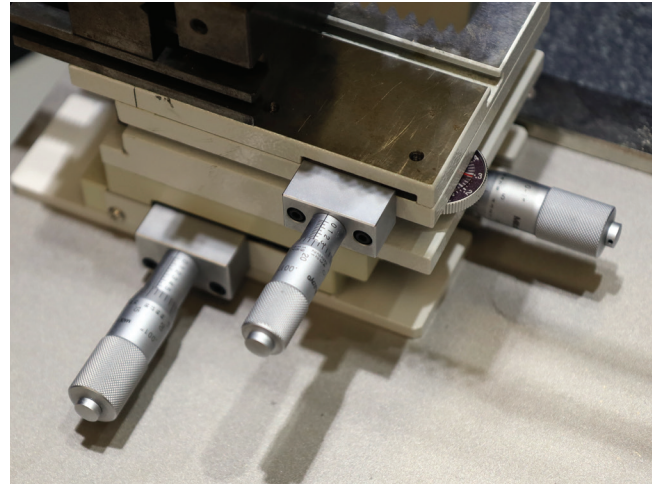

Typical OEM Applications

- Measurement instruments and gauges
- Optical and photonics equipment
- Medical and laboratory devices
- Positioning stages, fixtures, and mechanical assemblies
- Automated or semi-automated industrial systems
- Custom tooling and precision alignment mechanisms

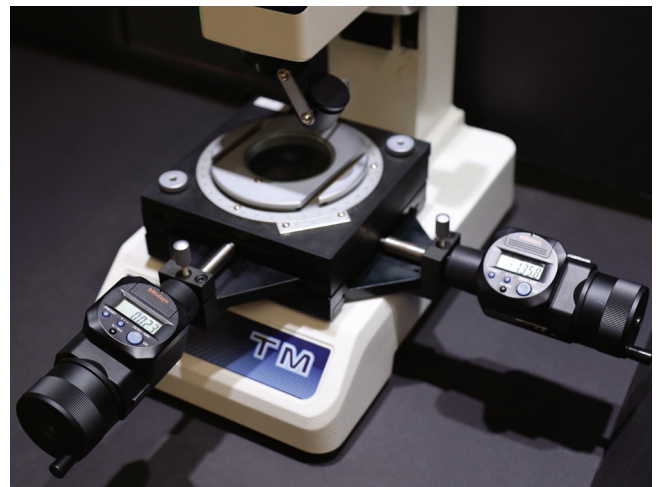
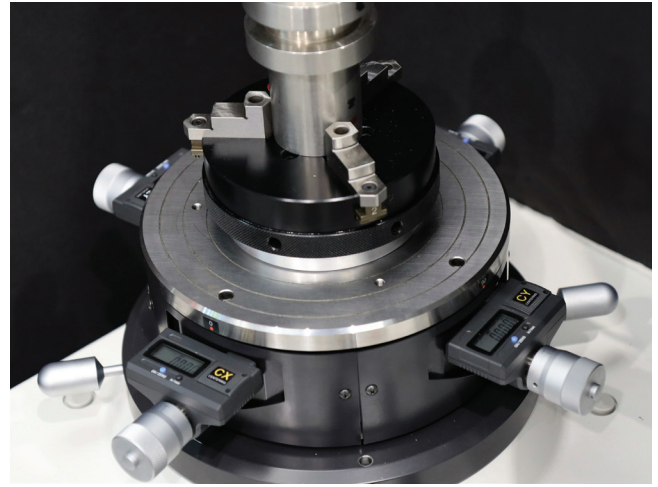

Custom-built Products (Product Example Introductions)

Micrometer heads have applications in many fields of science and industry and Mitutoyo offers a wide range of standard models to meet customers' needs. However, in those cases where the standard product is not suitable, Mitutoyo can custom build a head incorporating features better suited to your special application. Please feel free to contact Mitutoyo about the possibilities - even if only one custom-manufactured piece is required.

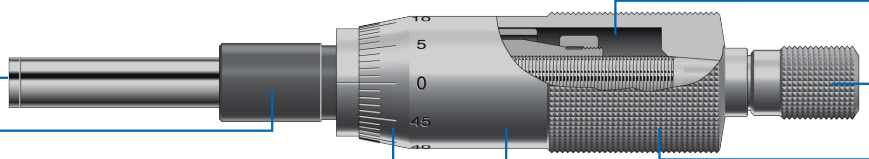

1. Spindle-end types

- Standard

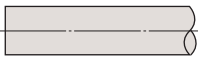

- Spherical



- Pointed

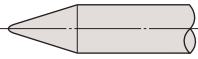

- Spline

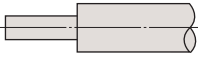

- Tapped

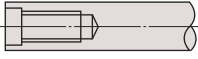

- Flanged

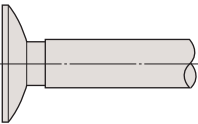

- Blade
(for non-rotating spindle type only)

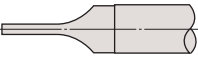

- Long spindle type is also available. Please consult Mitutoyo.

2. Stem types

A custom stem can be manufactured to suit the mounting fixture.

- Plain

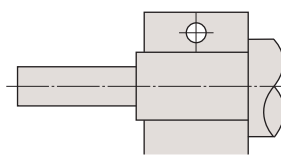
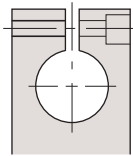

- Clamp nut

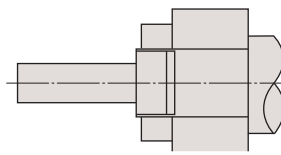
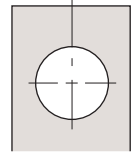

- Threaded

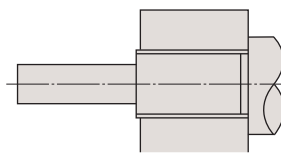
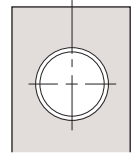

- Flanged

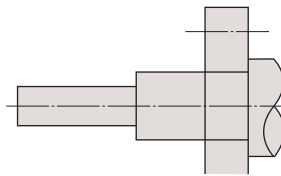
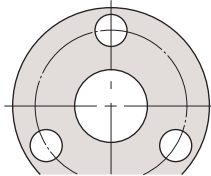

3. Scale graduation schemes

Various barrel and thimble scale graduation schemes, such as reverse and vertical, are available. Please consult Mitutoyo for ordering a custom scheme not shown here.

- Standard

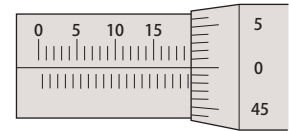

- Reverse

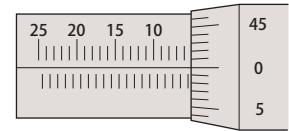

- Vertical

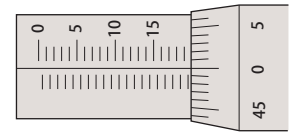

- Reverse vertical

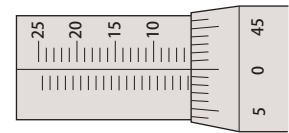

- Offset zero

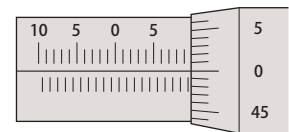

- Graduations only

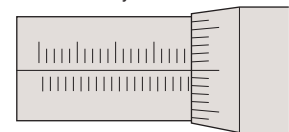

Customized micrometer heads can be offered even in one-off quantities. Do not hesitate to contact your nearest Mitutoyo sales office for details.

4. Logo engraving

A specific logo can be engraved as required.



5. Motor Coupling

Couplings for providing motor drive to a head can be designed.

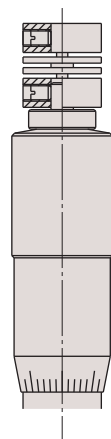

6. Thimble mounting

Thimble mounting methods including a ratchet, setscrew, and hex-socket head screw types are available.

- Ratchet

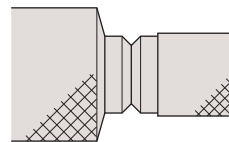

- Setscrew

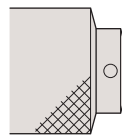

- Hex-socket head screw

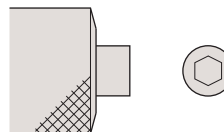

7. Spindle-thread pitch

Pitches of 1mm for fast-feed applications or 0.25mm for fine-feed can be supplied as alternatives to the standard 0.5mm. Inch pitches are also supported. Please consult Mitutoyo for details.

8. Lubricant for spindle threads

Lubrication arrangements can be specified by the customer.

9. All-stainless construction

All components of a head can be manufactured in stainless steel.

10. Simple packaging

Large-quantity orders of micrometer heads can be delivered in simple packaging for OEM purposes.

11. Spindle and nut (Precision feed screw)

The spindle can be used as a precision feed screw. The nut is machined in accordance with the specified dimensions.

For details, refer to "Precision Feed Screws" on page 45.

12. Accuracy inspection certificate

An accuracy inspection certificate can be supplied at extra cost. For detailed information, contact the nearest Mitutoyo Sales Office.

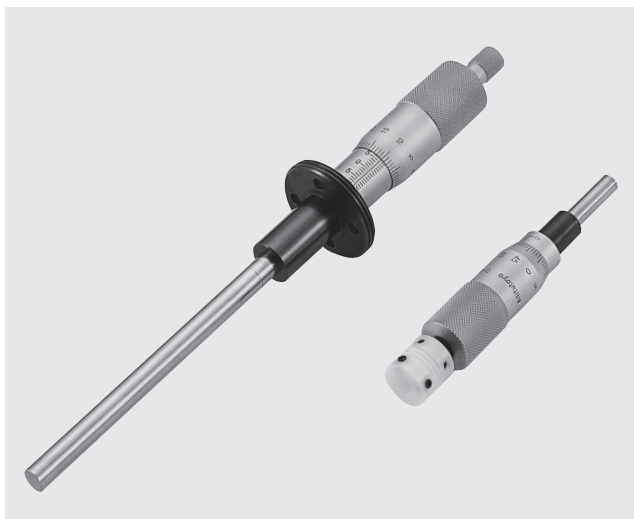

CAD Data Download for Micrometer Heads



2D/3D CAD data files* of the micrometer heads described in this catalog are available for download from the Mitutoyo home page. The data is supplied in formats common to most CAD systems.

To download, access the "Micrometer Heads" section under "Product Information" and then follow the procedure given below.

2D geometric data: DXF

3D geometric data: IGS / STP

* For some models only 2D data files are available.

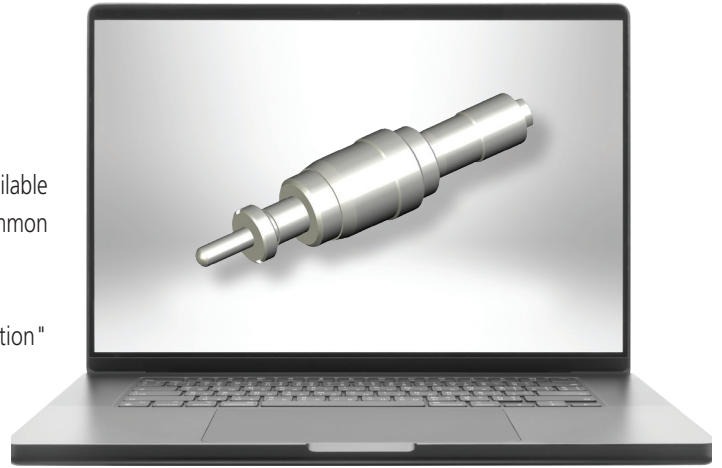

Mitutoyo home page <http://www.mitutoyo.co.jp>.



Find out more information by
emailing by info@mitutoyo.ca

www.mitutoyo.ca

We reserve the right to change prices and specifications without notice. Visit mitutoyo.ca/promotions to ensure pricing is up to date. Not valid with any other offer or promotion. This promotion is for Canadian market only.

Request formal quotation for complete details.

Note: All information regarding our products, and in particular the illustrations, drawings, dimensional and performance data contained in this printed matter as well as other technical data are to be regarded as approximate average values. We reserve the right to make changes to the corresponding designs. The stated standards, technical regulations, descriptions and illustrations of the products were valid at the time of printing. In addition, the products are subject to Canadian Export Administration Regulations. Re-export or relocation of Mitutoyo products may require prior approval by an appropriate governing authority.

Mitutoyo products are sold through authorized distributors. Please contact your local Mitutoyo Distributor for Canadian pricing. Find your distributor at www.mitutoyo.ca/find-a-distributor/

Mitutoyo

**EXPERIENCE MITUTOYO
M³ SOLUTION CENTERS**

Mississauga ON
2121 Meadowvale Blvd.,
Mississauga, ON L5N 5N1
Tel. (905) 821-1261

Laval, QC
5539 Ernest-Cormier
Street, Unit B, Laval,
QC, H7C 2S9

www.mitutoyo.ca info@mitutoyo.ca