

Mitutoyo

DURAMILL
INDUSTRIAL SUPPLIES
an MSC Company

Email: sales@duramill.ca
Tel: (905) 738-8665 | Fax: (905) 738-4862
www.duramill.ca
6877 Edwards Blvd., Mississauga, ON L5T 2T9

Mitutoyo Quality

CNC Coordinate Measuring Machine CRYSTA-Apex V PLUS Series

Coordinate Measuring Machines



Coordinate Measuring Machines
that adapt to changing
environments

Catalog No. E16036-CAD

Opening the future

CNC coordinate measuring machines that adapt to changing environments.

The new CRYSTA-Apex V PLUS 500/700/900 leads CMMs in innovation with outstanding accuracy, advanced functions, and proven reliability. Its expanded temperature range of guaranteed accuracy now allows the CRYSTA-Apex V to be installed outside of temperature-controlled measuring rooms.

The new CRYSTA-Apex V series of CMMs delivers more efficient measurement operations, reduces costs, and cuts impacts to the environment. The rebirth of the CRYSTA Apex-V is paving a new path to the future of quality control.

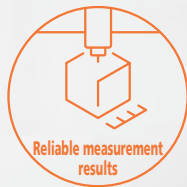

CRYSTA-Apex V PLUS574



CRYSTA-Apex V PLUS7106



CRYSTA-Apex V PLUS9108



INDEX

Needs of the Customer P4-5

- Need 01 Need to lower operating costs without losing performance P6-7
- Need 02 Need to reduce inspection labor hours when short-staffed P8-9
- Need 03 Need to improve yield by reducing variation and rework P10

- Need 04 Need for fast, accurate measurement of complex parts P11
- Need 05 Need to increase operation rate without downtime P12
- Need 06 Need to ensure dependable performance post-installation P13

of quality



Probes	P14-15
Software	P16-17
Options	P18-19

Specifications, external dimensions

CRYSTA-Apex V PLUS 500 Series	P20-21
CRYSTA-Apex V PLUS 700 Series	P22-23
CRYSTA-Apex V PLUS 900 Series	P24-25
Threaded insert locations	P26

There are many issues in shop-floor environments...

Need
01

Need to lower operating costs without losing performance

You want to reduce the running costs associated with maintaining air conditioning at 68 °F (C20 °C) in the measuring room and supplying air to the CMM main unit. You want to reduce operating cost by minimizing power consumption, with the added advantage of decreasing CO₂ emissions.

Solved with
V PLUS!

First-pass quality, reduce rework
Wide temperature range of guaranteed accuracy
Real-time temperature compensation
Air reduction function

For details,
see pages 6 and 7.

Need
02

Need to reduce inspection labor hours when short-staffed

You want to shorten the time spent on measurement as well as overall lead time — such as the time required for temperature acclimation and transporting parts to inspection. You also want to understand how to address your labor-shortage challenges.

Solved with
V PLUS!

High-speed scanning using design value profiling
Real-time temperature compensation
Up to four roles filled by one machine
MiCAT Planner, software for automatically generating measurement programs

For details,
see pages 8 and 9.

Need
03

Need to improve yield by reducing variation and rework

You want to improve overall throughput by optimizing your measurement process while maintaining consistent accuracy.

Solved with
V PLUS!

High-accuracy point measurement
Thermal expansion origin point setting function

For details, see
page 10.

Are you struggling with any of these?

Need

04

Need for fast, accurate measurement of complex parts

For workpieces with complex shapes such as gears, turbine blades, and camshafts, it is not possible to measure all of the items using general measuring tools. You want to know how to measure these items accurately and efficiently.

Solved with
V PLUS!

NonStop Scanning function
Multi-probe support
Gear analysis
Rotary table

For details,
see page 11.

Need

05

Need to increase operation rate without downtime

You want to improve productivity by making the most of your equipment.

Solved with
V PLUS!

Quick Launcher
Monitoring service

For details,
see page 12.

Need

06

Need to ensure dependable performance post-installation

Solved with
V PLUS!

Mitutoyo's unique support system

For details,
see page 13.

Need
01

Need to lower operating costs without losing performance

Solved with CRYSTA-Apex V PLUS !

The CRYSTA-Apex V PLUS series reduces running costs with an expanded temperature range of guaranteed accuracy and air reduction function.

Solution
1

Achieves a wide temperature range of guaranteed accuracy

A new structure has been adopted that prevents distortion even when temperature changes occur, expanding the temperature range of guaranteed accuracy to 59 to 86 °F (15 to 30 °C). The standard temperature environment for length measurement is set to 68 °F (20 °C), but real-time temperature compensation means that even in summer, it can be used in environments up to 82.4 °C (28 °C), reducing costs associated with running and managing air conditioning systems. In addition, if the on-site environment is between 59 to 86 °F (15 to 30 °C) with little temperature change, the machine can be installed and used on-site without the need for a measuring room.

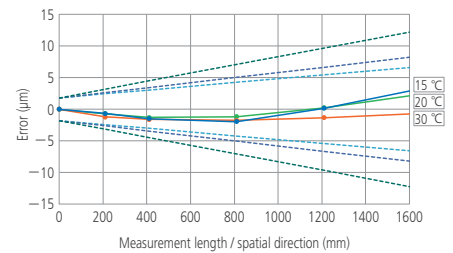

Accuracy guaranteed temperature range

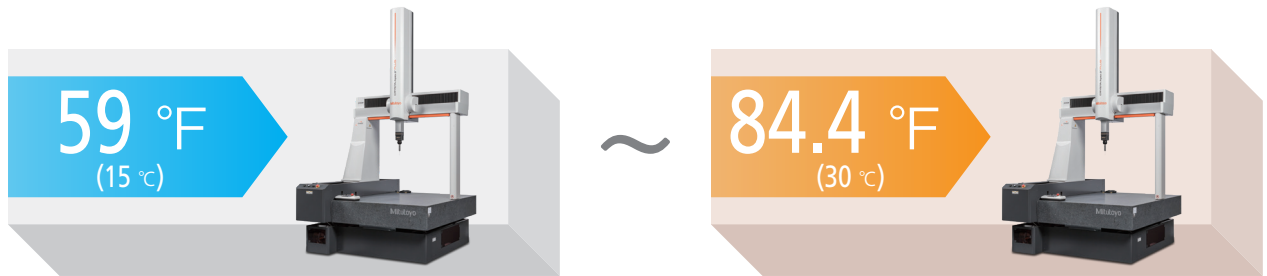

Comparison of measurement with and without workpiece temperature compensation (hole pitch)

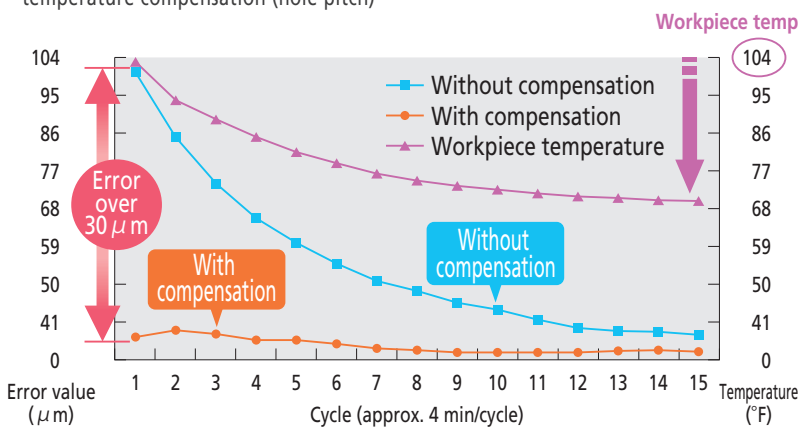

The temperature of the workpiece can be captured in real time and reflected in the measurement results.

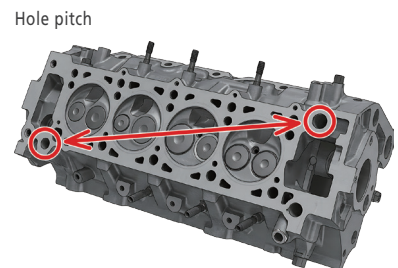

Solution 2

Air reduction function that minimizes unnecessary air consumption and reduces power consumption



When the CMM is set to ECO mode, the air reduction function is activated which turns off the servo motors and stops air consumption while the machine is on standby waiting to perform measurements. When measurements are resumed, power and air supplies are automatically restored, thereby reducing power consumption and minimizing air consumption. You can set the length of waiting time before ECO mode is activated.



Air reduction function cost comparison (annual cost)

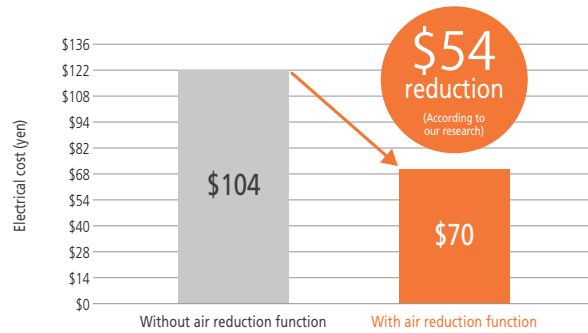

Conditions: Comparison when a CMM is intended to be used for 8 hours a day, but is actually on standby for 4 hours a day.
(The cost of compressed air is calculated at \$0.20/m³)

Solution 3

An environmentally advanced CNC coordinate measuring machine that contributes to reducing CO₂ emissions



This CMM not only reduces power consumption but also contributes to reducing CO₂ emissions. As an initiative for achieving a sustainable society, it is also effective in raising and promoting environmental awareness.

Comparison of maintaining measuring room temperature at 20 °C and 28 °C, when outside temperature is 35 °C.

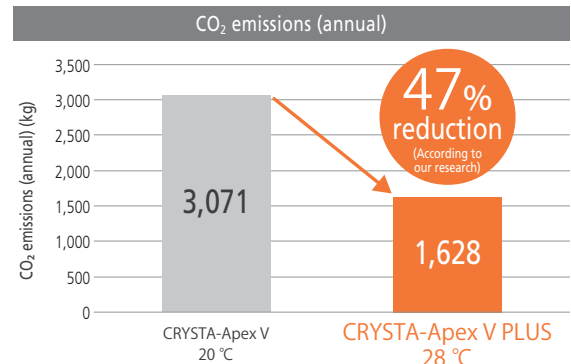
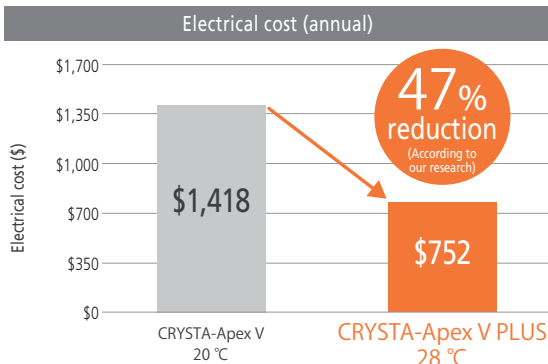

Conditions: Measuring room size: 196.3 ft² and 9'-10" in height
Electricity cost is calculated based on the guideline price of \$0.21/kWh published by the National Fair Trade Council for Home Electrical Appliances and Materials.
CO₂ emissions are calculated using the CO₂ emission coefficient of 1.0 lb.-CO₂/kWh published by Tokyo Electric Power Company in fiscal 2018.

Need
02

Need to reduce inspection labor hours when short-staffed

Solved with CRYSTA-Apex V PLUS !

By speeding up measurement and reducing effort, worker hours, and waiting time, this CMM supports improved work efficiency and reduced measurement time. This helps resolve labor shortage issues and contributes to improving on-site productivity.

Solution
1

Reduces measurement times with design value scanning measurement along with excellent drive speed and acceleration

Not only can the CRYSTA-Apex V PLUS perform high-speed measurements with a maximum drive speed of 519 mm/s and a maximum drive acceleration of 2309 mm/s², but it can also perform high-speed scanning at up to 120 mm/s with 2D/3D design value scanning measurement. This enables workpieces with complex shapes to be measured at high speeds without sacrificing accuracy, thereby shortening measurement times even more.



Solution
2

Measurement immediately after processing, without need for temperature acclimation

The real-time temperature compensation function minimizes errors due to temperature changes. No temperature acclimation time is required, so measurement can be performed immediately. In addition, it can be installed in a general air-conditioned environment, reducing the effort and travel time that would be required to transport test items to a temperature-controlled measuring room.

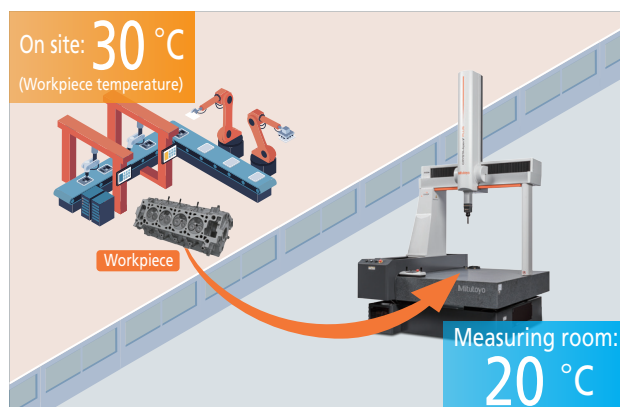

Solution
3

Up to four roles filled by one machine Contributes to work efficiency

By adding gear analysis software, contour software, and a roughness probe (all optional), one machine can be made to perform four functions: dimensional measurement, form measurement, gear measurement, and roughness measurement.

This reduces labor and space and eliminates the need for changeover, resulting in reduced worker hours. There is no need to learn how to operate multiple measuring machines, which helps to alleviate labor shortages.

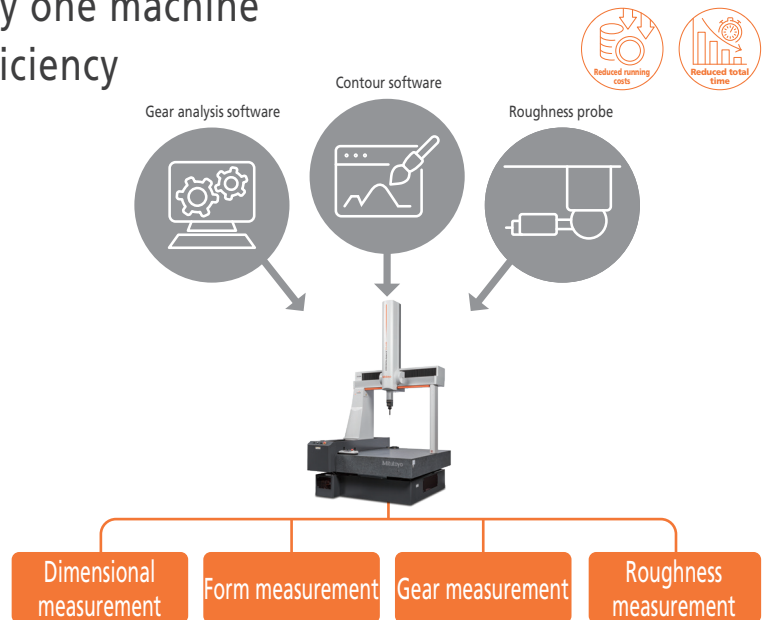

Solution
4

Anyone can easily create high-quality measurement programs

MiCAT Planner enables automatic generation of expert-level measurement programs through intuitive operation. Anyone can use it to create high-quality programs. Since the measurement program is created from the 3D CAD model, it can be created before the object to be measured is completed, significantly shortening the lead time. The measurement program created not only prevents the probe from trying to travel through the workpiece including the jig, but also takes into account the entire measurement and takes the shortest possible time, which greatly helps improve productivity.

For software details, see page 17.

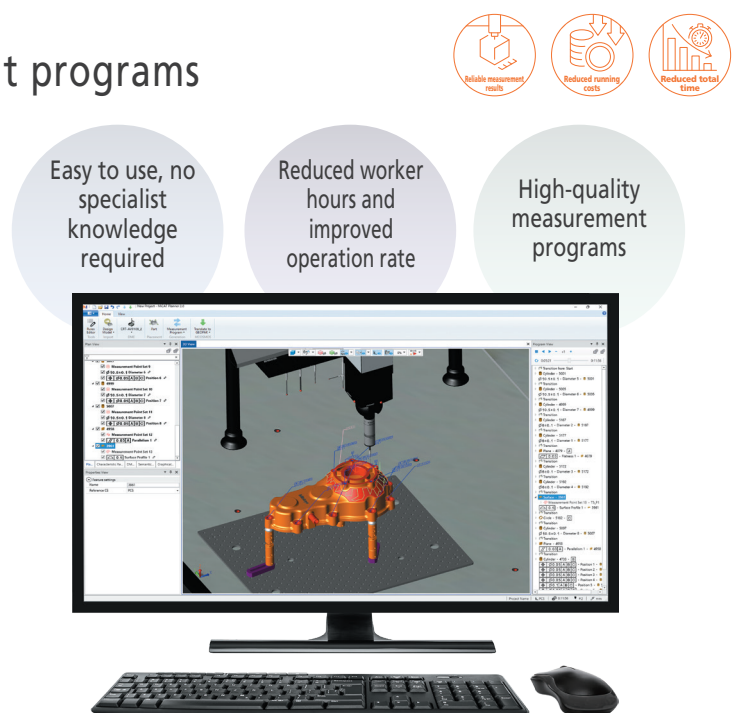

Need
03

Need to improve yield by reducing variation and rework

Solved with CRYSTA-Apex V PLUS !

In addition to the high accuracy of the maximum permissible error of length measurement, $E_{0, MPE} = (1.8 + 3L/1000) \mu\text{m}$, the wide variety of measurement methods and temperature compensation technology enable stable measurement.

Solution
1

Stable repeatability through high-accuracy point measurement

When the probe tip comes into contact with the workpiece, the tip briefly pauses for stabilization, eliminating causes. This eliminates the source of dynamic errors, enabling highly accurate and repeatable measurements.



Solution
2

Temperature compensation origin point setting function for more accurate temperature compensation

When environmental temperatures change, the workpiece expands or contracts from the position where it is fixed by the jig. Conventional temperature compensation functions use the coordinate origin point of the workpiece or measuring machine as the starting point, but with the new CRYSTA-Apex V PLUS CMM, you can set the position where it is fixed by the jig as the temperature compensation origin point to enable accurate temperature compensation.

Comparison of measurement with and without workpiece temperature compensation (difference from true value of 20 °C)

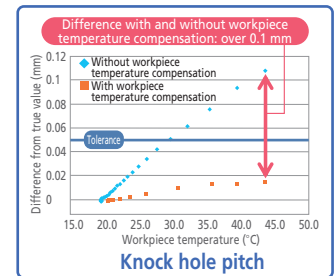
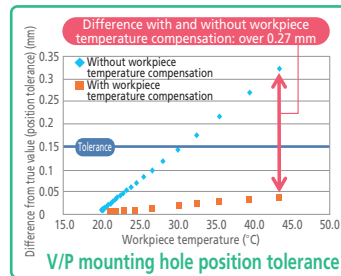

Workpiece temperature compensation origin point
By setting the workpiece temperature compensation origin point separately from the workpiece origin point, more accurate temperature compensation is made possible.

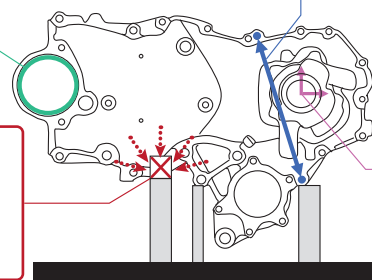

Workpiece origin point

Need 04

Need for fast, accurate measurement of complex parts

Solved with CRYSTA-Apex V PLUS !

The CRYSTA-Apex V PLUS not only provides excellent measurement functions, it also has a lineup of probes that are compatible with a wide variety of workpiece shapes. Furthermore, various optional items are available to meet a wide range of measurement needs.

Solution 1

NonStop Scanning function for efficient scanning measurement



The NonStop Scanning function allows scanning measurements to be made, even when there are recesses such as notches or holes, by allowing scanning measurement to skip over the recesses. Until now, it would be necessary to create a measurement program to avoid recesses, but this is no longer a concern, allowing significant time to be saved.

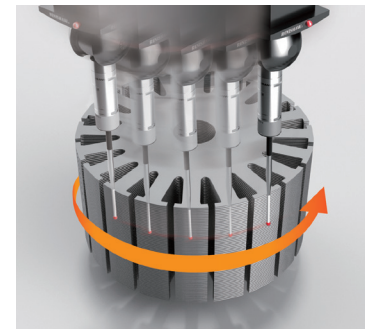

Solution 2

A variety of probes to suit the item being measured



The auto probe changer makes it possible to switch to the optimal probe for the workpiece, such as a non-contact laser probe or image probe. This means a variety of measurements can be performed smoothly with one measuring system.

For probe details, see pages 14 and 15.



Solution 3

Options to support a wide range of measurements



Various optional accessories are available to expand the scope of measurement, including a rotary table effective for measuring free-form surfaces and rotating objects such as gears, and a clamping tool that can secure the object to be measured.

For option details, see pages 18 and 19.



Need
05

Need to increase operation rate without downtime

Solved with CRYSTA-Apex V PLUS !

With its excellent operability, the CRYSTA-Apex V PLUS can even be used by non-expert operators, increasing the operation rate. Additionally, by using monitoring services and other methods, the operating status can be visualized, enabling measurement equipment to operate without interruption.

Solution
1

Excellent operability, easy and convenient for anyone to use



The Quick Launcher comes as a standard feature, allowing intuitive operation with icons and easy execution of measurement programs. After easily registering your measurement program as an icon, all you need to do is place the workpiece and touch the icon.

Additionally, the joystick box combines easy-to-understand operation buttons with a lightweight, handheld controller, allowing for easy operation at your fingertips.

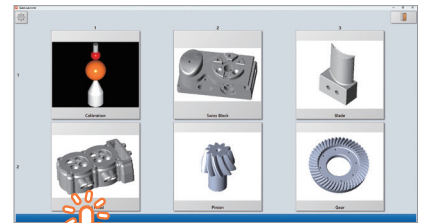

Easy startup of operation for any user. Simply place the workpiece and immediately commence measurement via an intuitive operation screen.



Joystick box

Solution
2

Monitoring service to ensure uninterrupted operation of measurement equipment



Our monitoring service not only allows you to remotely monitor operating status, but also lets you know when consumable parts are approaching the end of their lifespan.

By replacing parts before they break, you can prevent or reduce downtime.

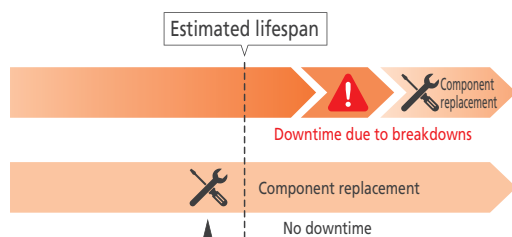

Monitoring allows you to understand the status of the CMM and take measures such as maintenance or part replacements before breakdowns occur.

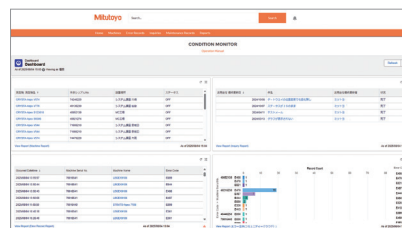

Monitoring service screen

Monitoring service is available with the "Ultimate Contract" or "Visualization Service" options.

Depending on your country or region, this service may not be available. Please contact your nearest branch for details.

Need
06

Need to ensure dependable performance post-installation

Solved with CRYSTA-Apex V PLUS !

Support also falls under the Mitutoyo brand. The relationship between Mitutoyo and the customer's worksite does not end at sale; it starts there.

Mitutoyo's unique service system



Mitutoyo provides the high-quality service that only a comprehensive manufacturer can deliver, so that all our customers can use our products at their intended level of performance. Our expert staff will support you with a variety of services, from setup to software training, inspection, calibration, precision adjustment, and maintenance and repairs.



Locations
30 countries
and regions



Agency network
Over **60** countries



For more information about Mitutoyo Measurement Academy, please check here.

PROBES

Achieve highly accurate, efficient measurement with probes that match the workpiece shape

Compact high-accuracy scanning probe SP25M

A compact high-accuracy scanning probe with an outer diameter of 25 mm. It supports scanning measurement, high-accuracy point measurement, and centering point measurement. By utilizing the probe change system, it is possible to fully automate the measurement of parts with various shapes.

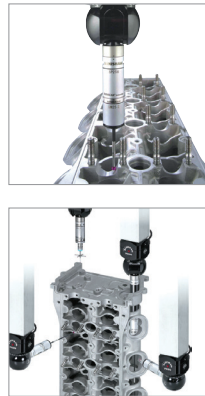

5-axis control touch-trigger system PH20

Positioning at any angle is possible, and high-speed measurement is achieved by head touch. It can also measure inclined surfaces and holes with narrow openings and wide bottoms, and there is no need to worry about shank interference when measuring deep holes. Measurement programs can be created on a PC using 3D CAD data.



Non-contact laser probe SurfaceMeasure

This probe emits lasers, allowing it to measure the surface shape of an object without contact, quickly and with high accuracy. It can handle soft materials and workpieces with complex shapes that are difficult to measure using contact methods, and can efficiently capture minute surface irregularities and shapes. It generates precise 3D shape data.



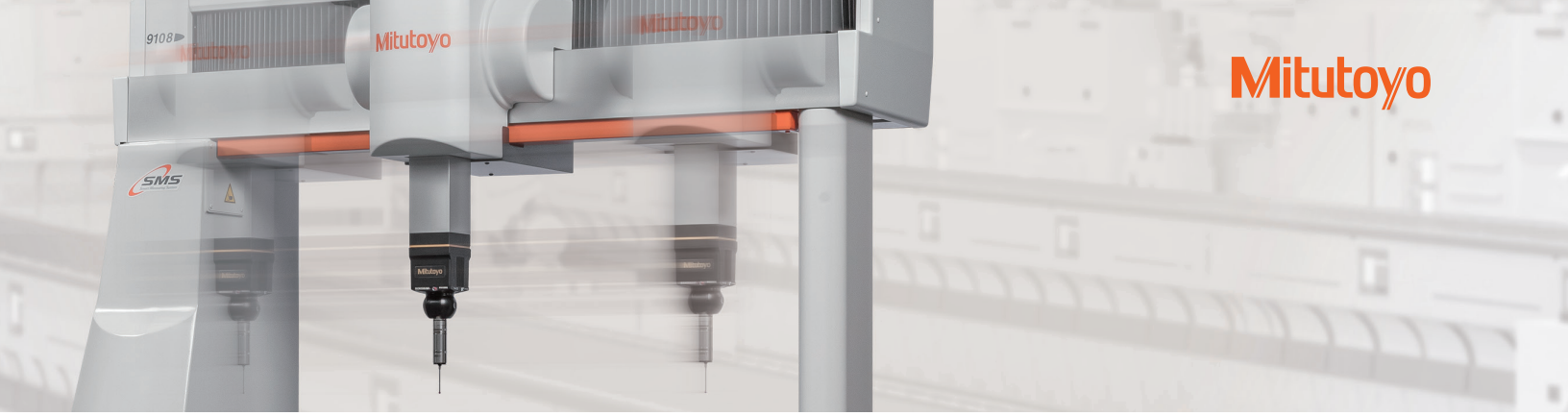

Separator dies

Electric vehicles

The low-measuring-force, high-accuracy scanning probe enables curved surface and cross-section measurement of precision dies for separators. 3D error analysis and cross-sectional shape analysis can be performed from the acquired measurement point cloud.

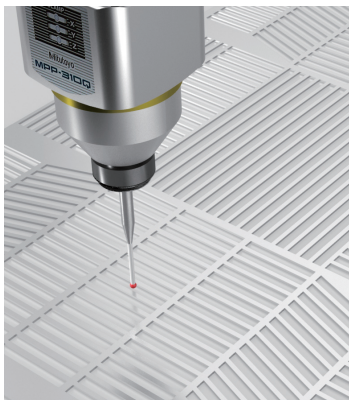

Impellers

Automobiles

Impellers are measured using a non-contact laser probe that has highly robust performance and suppresses multiple reflections. It has the same accuracy as a contact probe and has high shape reproducibility.

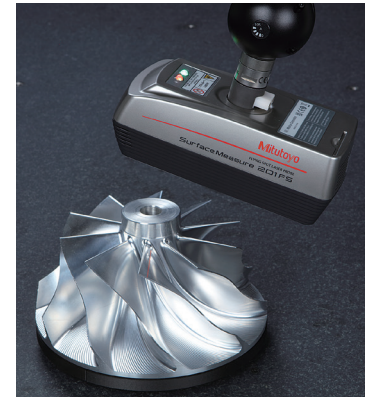

Motor cores

Electric vehicles

Measures the straightness and cross-sectional shapes of laminated motor cores. It can accommodate measurements of three-dimensional objects, such as dimensional measurement from the side or any at height.

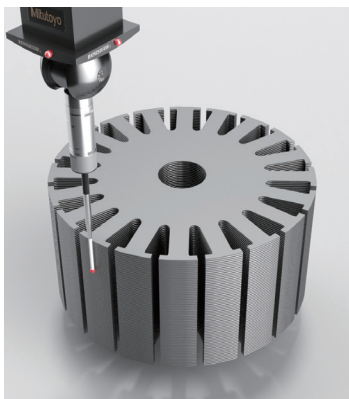

Blades

Aircraft

The cross section of an aircraft engine blade can be measured using a compact high-accuracy scanning probe. This enables fast and stable measurement even for workpieces with potentially large errors, such as castings.



Artificial joints

Medical care

A compact high-accuracy scanning probe can be used to measure the free-form surfaces of artificial joints, and 3D error analysis can be performed from the acquired measurement point cloud.



Transmission cases

Power trains

Compared with contact probes (scanning), non-contact laser probes can drastically reduce measurement times. The top and inside are measured simultaneously by scanning from three directions at once, reducing the number of orientation changes and allowing even complex shapes to be measured efficiently.



SOFTWARE

Software that enables easy, efficient and reliable measurement

Data processing system for coordinate measuring machines

MCOSMOS

This is a family of data processing programs for CMMs that runs on Windows. With an extensive lineup of optional software and compatibility with a variety of probes, it enables fully automated measurement of all kinds of workpieces.



Scan the QR codes for more information.

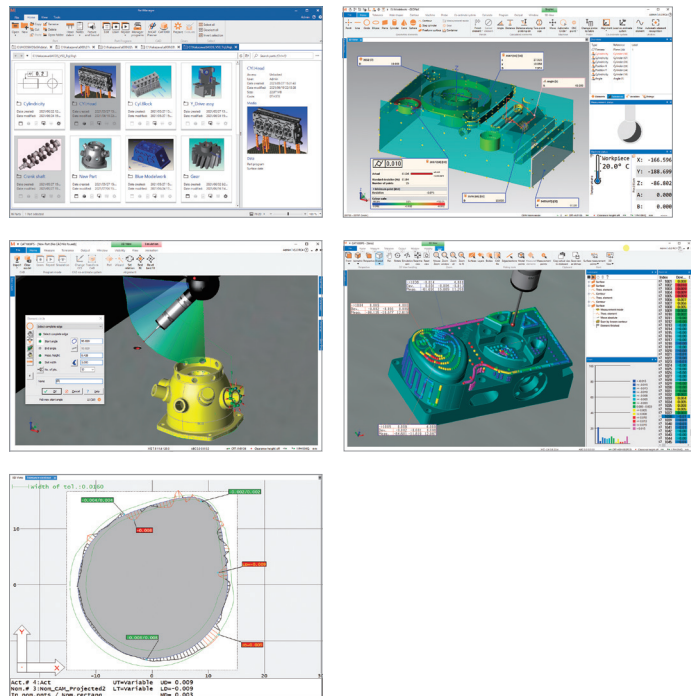

Gear measurement and evaluation software

GEARPAK Express

Part programs are automatically generated by entering the specification data of the gear to be measured and setting the measurement and evaluation conditions. Intuitive operability, high-speed scanning measurement, and quick feedback improve the efficiency and reliability of gear measurement.

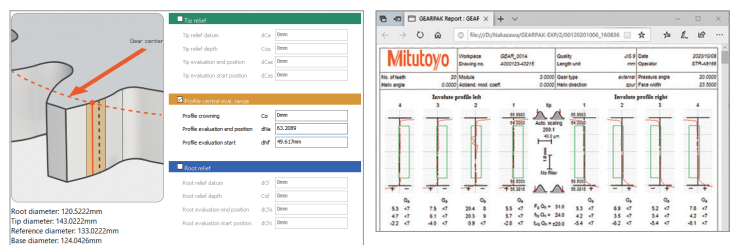
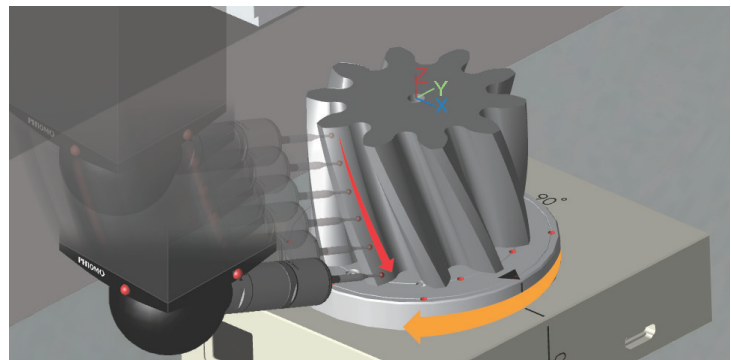

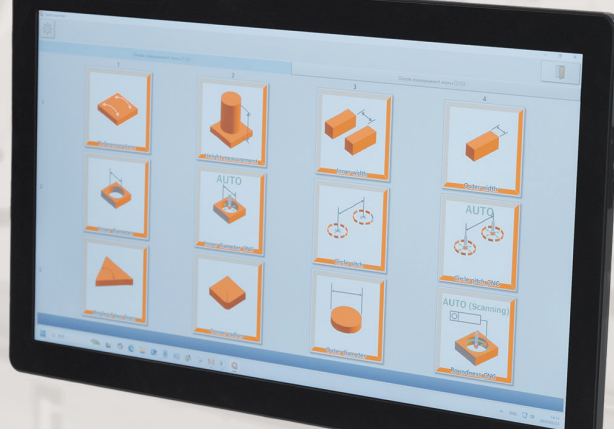

Automatic measurement program generation software for CMMs

MiCAT Planner

With the addition of tolerance information to a 3D CAD model, the software reads the tolerance information, determines the measurement points, and generates an automatic measurement program. This enables measurement programs to be created more efficiently than with the conventional method (teaching).



Scan the QR code to watch a video.

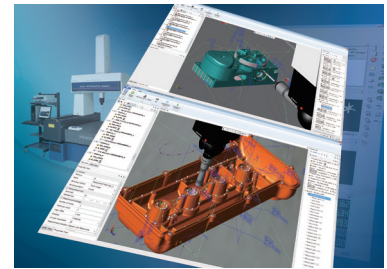

Optimization of measurement programs

The shortest and fastest measurement path is automatically generated, taking into account all measurement items and minimizing the changing of probe orientation and stylus.

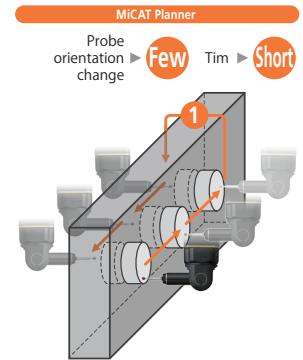
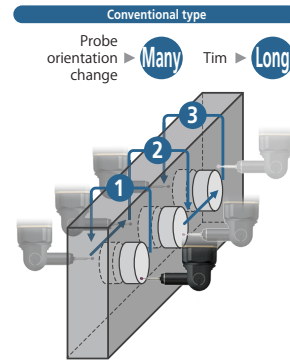
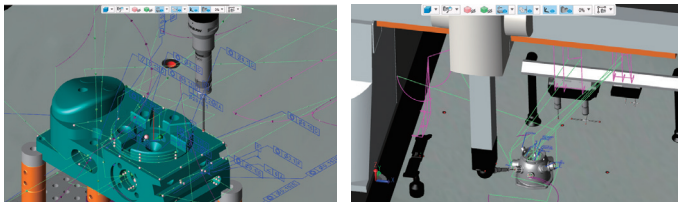

Rule editor function

Detailed measurement rules can be set, making it possible to prevent inconsistency in measurement quality between program creators.

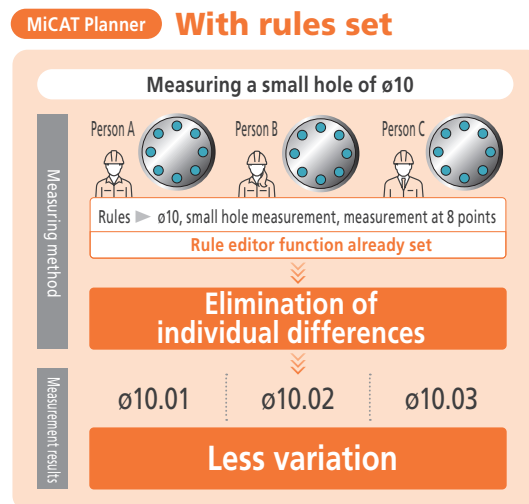
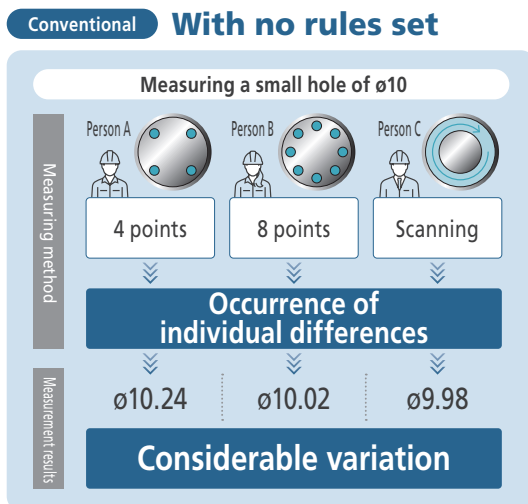

OPTIONS

A wide range of options available to expand the scope of measurement and improve efficiency

Automation example

Since highly accurate measurements can be performed in a wide range of temperature environments, a dedicated measuring room is not required, and in-line and line-side measurements can be automated during the manufacturing process (line). This significantly reduces measurement time and improves efficiency.



Rotary table

This is an option for CNC coordinate measuring machines developed mainly for measuring rotating objects (gears, impellers, screw rotors, cylindrical cams, etc.) with high accuracy and efficiency. It can also be used in combination with a scanning probe to perform synchronous scanning measurements, enabling a wide variety of contour measurements, further expanding the range of applicable measurement operations.

MRT240

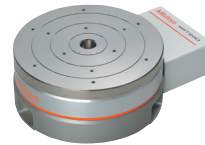

MRT320

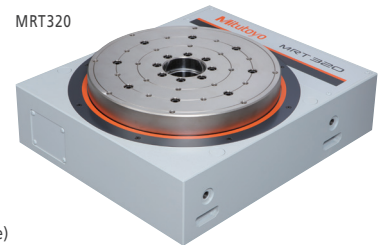

QS600/QS800 (large rotary table)

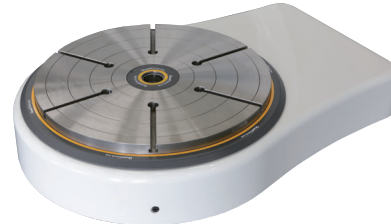

Rotary table MRT240 installation example

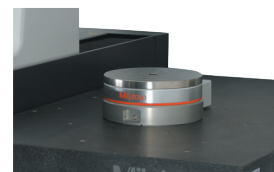

Large rotary table installation example

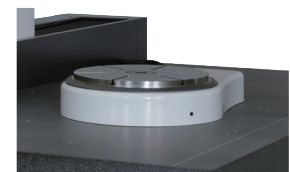

Eco-Fix Kit clamping tool

This Mitutoyo clamping tool is a clamping system that allows you to easily secure a variety of objects by combining elements like toy blocks.



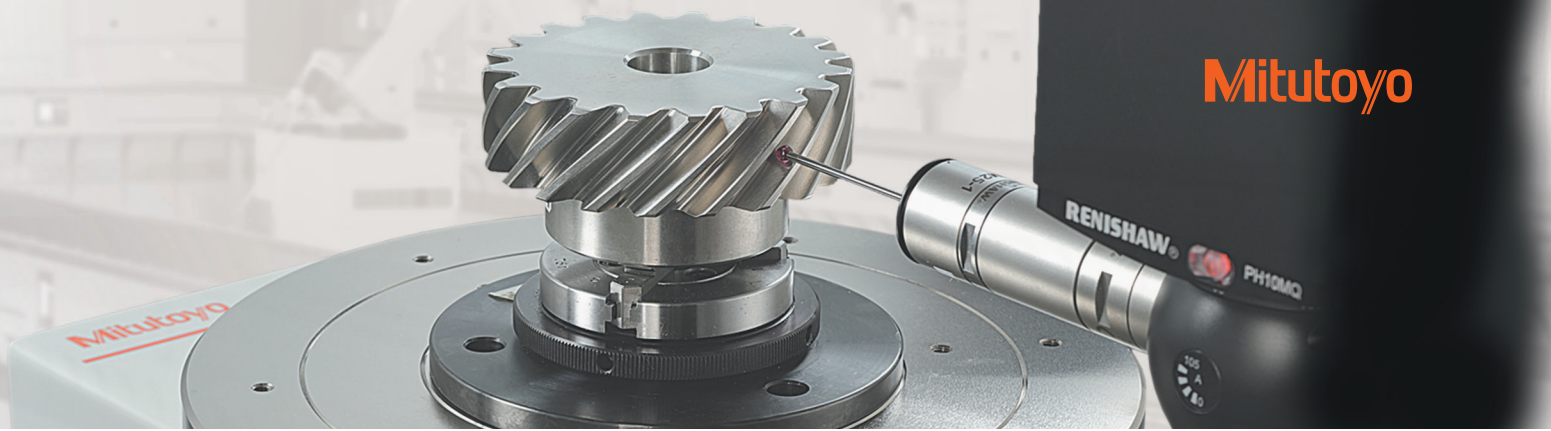

Achieving a smart factory through visualization

Mitutoyo uses the "SMS (Smart Measuring System)" which provides online monitoring of precision measuring equipment in operation. Furthermore, the "Condition Monitor" and "MeasurLink®" options can help you to achieve a smart factory.



Remote monitoring of measuring instrument operating status

Status Monitor

The operational status of network-connected coordinate measuring machines can be centrally monitored. You can also simultaneously monitor other measurement instruments on the network. This contributes to reducing waste and improving the operating rate of production equipment.

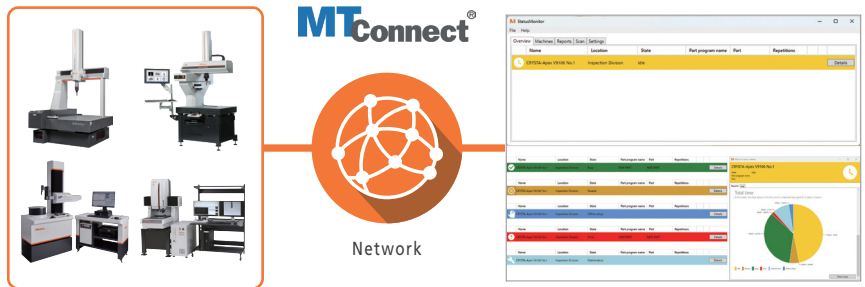

Preventive maintenance through status monitoring of CMMs

Condition Monitor

Status information of the CMM, such as the probe touch count and the travel distance on each axis, is constantly collected and stored. Visualization of status helps prevent sudden operation shutdown, enabling equipment to operate without interruption.

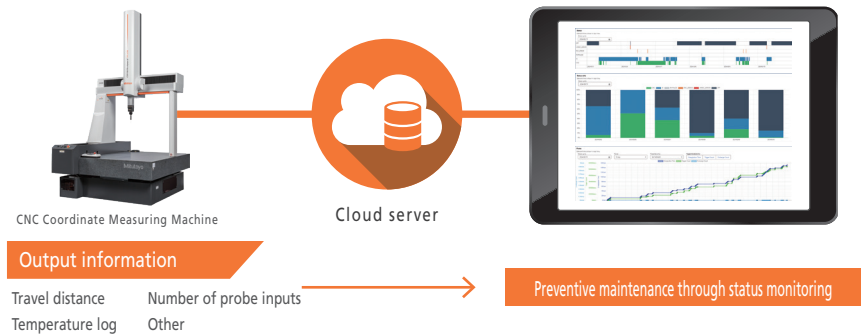

Collects and analyzes measurement data in real time

MeasurLink®



Measurement data from various measuring devices connected via a network is collected and stored on a server, and statistical processing is performed in real time, preventing the occurrence of defective products by visualizing quality.

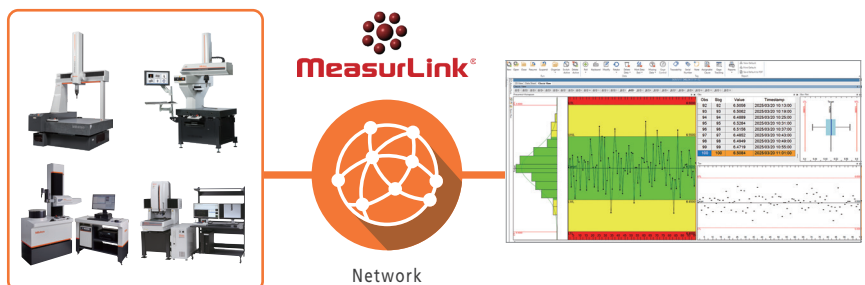

MeasurLink® is a registered trademark of Mitutoyo Corporation in Japan and Mitutoyo America Corporation in the United States.

Main unit specifications

		CRYSTA-Apex V PLUS544	CRYSTA-Apex V PLUS574
Measuring range [mm]	X	500	
	Y	400	700
	Z	400	
Guide method		Air bearing for each axis	
Drive speed [mm/s]	CNC MODE (Key selector switch: AUTO)	Each axis: Max. 300 (Max. combined speed: 519) Measuring speed: 1 - 8	
	CNC MODE (Key selector switch: MANUAL)	Each axis: Max. 138 (Max. combined speed: 239) Measuring speed: 1 - 8	
	J/S MODE	Drive speed: 0 - 80 Measuring speed: 0 - 3	
		Fine speed: 0 - 0.05	
Driving acceleration [mm/s ²]		Each axis: 1333 (Max. combined acceleration: 2309)	
Length measuring method		Linear encoder	
Resolution [mm]		0.0001	
Measuring table	Material	Granite	
	Size (load surface) [mm]	638x860	638x1160
	Workpiece fixing method	M8x1.25	
Workpiece	Maximum height [mm]	545	
	Maximum mass [kg]	180	
Main unit key dimensions [mm]	Height	2185	
	Width	1082	
	Depth	1191	1548
Machine mass [kg] (including controller, excluding workpiece)	Stand	542	691
	Vibration isolating stand	747	955
Power supply	Voltage, Frequency		100-120/200-240 VAC ±10 %, 50/60 Hz
	Power consumption [kW]	Standard (PH10MQ + TP200)	Max.: 0.23, Avg.: 0.13
		With full options	Max.: 1.5
Air usage conditions	Air pressure used		0.4 MPa (4 kgf/cm ²)
	Air consumption		50 L/min (under standard conditions) (Air source: 100 L/min)
Operating temperature		10 to 35 °C	

Note: When using the "JSBOX-HANDY2 configuration (UC4805)" (Code No. 06AGE357), operation using Fine Speed (J/S MODE) is not possible.

Accuracy specifications

Probe configuration	Probe	TP20	TP200	SP25M		SP600Q	MPP-310Q *1	PH20 *2 + TP20
	Module			SM25-1 SH25-1	SM25-2 SH25-2			
Maximum permissible error of length measurement $E_{0,MPE}$ [μm]	Temperature environment 1 *3	2.3 + 3L/1000	2.0 + 3L/1000	1.8 + 3L/1000	1.9 + 3L/1000	1.8 + 3L/1000	1.8 + 3L/1000	2.3 + 3L/1000
	Temperature environment 2 *3	2.3 + 4L/1000	2.0 + 4L/1000	1.8 + 4L/1000	1.9 + 4L/1000	1.8 + 4L/1000	1.8 + 4L/1000	2.3 + 4L/1000
	Temperature environment 3 *3	2.3 + 6.5L/1000	2.0 + 6.5L/1000	1.8 + 6.5L/1000	1.9 + 6.5L/1000	1.8 + 6.5L/1000	1.8 + 6.5L/1000	2.3 + 6.5L/1000
Maximum permissible error of length measurement $E_{150,MPE}$ [μm]	Temperature environment 1 *3	2.8 + 3L/1000	2.5 + 3L/1000	1.8 + 3L/1000		1.8 + 3L/1000	1.8 + 3L/1000	
	Temperature environment 2 *3	2.8 + 4L/1000	2.5 + 4L/1000	1.8 + 4L/1000		1.8 + 4L/1000	1.8 + 4L/1000	
	Temperature environment 3 *3	2.8 + 6.5L/1000	2.5 + 6.5L/1000	2.3 + 6.5L/1000		2.3 + 6.5L/1000	2.3 + 6.5L/1000	
Maximum permissible error of length measurement $E_{300,MPE}$ [μm]	Temperature environment 1 *3				2.0 + 3L/1000			
	Temperature environment 2 *3				2.0 + 4L/1000			
	Temperature environment 3 *3				2.5 + 6.5L/1000			
Maximum permissible limit of the repeatability range $R_{0,MPL}$ [μm]		1.9	1.6	1.4	1.5	1.4	1.4	1.9
Maximum permissible scanning mode form error on a sphere $P_{Form.Sph.Scan.PP:Tact,MPE}$ [μm]				2.4	2.5	2.4	1.9	
Maximum permissible scanning mode time $P_{Sph.Scan.PP:Tact,MPL}$ [Sec]				50	50	50	90	
Maximum permissible single-stylus form error $P_{Form.Sph.1x25:SS:Tact,MPE}$ [μm]		2.3	2.0	1.8	1.9	1.8	1.6	2.3

All accuracy specifications are based on use of a standard stylus. Standard stylus: TP20: ø4x10, TP200: ø4x10, SP25M: ø4x50, SP600Q: ø4x50, MPP-310Q: ø4x18, PH20: ø4x12

Accuracy specifications for scanning probes (SP25M, SP600Q, MPP-310Q) are based on high accuracy mode.

The $E_{0,MPE}$, $E_{150,MPE}$, $E_{300,MPE}$ and $R_{0,MPL}$ testing and evaluation methods comply with ISO 10360-2:2009 (JIS B 7440-2:2013).

The $P_{Form.Sph.Scan.PP:Tact,MPE}$ and $P_{Form.Sph.1x25:SS:Tact,MPE}$ testing and evaluation methods comply with ISO 10360-5:2020 (JIS B 7440-5:2022).

L = given measurement length (unit): mm

*1: Requires custom-made main unit.

*2: For the probe system, accuracy is guaranteed using CMM touch measurement. However, $E_{150,MPE}$ and $E_{300,MPE}$ are not guaranteed. Additionally, accuracy may decrease if the length or mass is increased by using a stylus extension or a non-standard stylus.

*3: For temperature environments 1 to 3, refer to "Temperature environment", below.

Temperature environment

		Temperature environment 1	Temperature environment 2	Temperature environment 3
Accuracy guaranteed temperature	Temperature range	18 to 22 °C	16 to 26 °C	15 to 30 °C
	Temperature change	2 °C in 1 hour	2 °C in 1 hour	
		2 °C in 24 hours	5 °C in 24 hours	
Temperature gradient		1 °C per 1 m (both vertically and horizontally)		

External dimensions

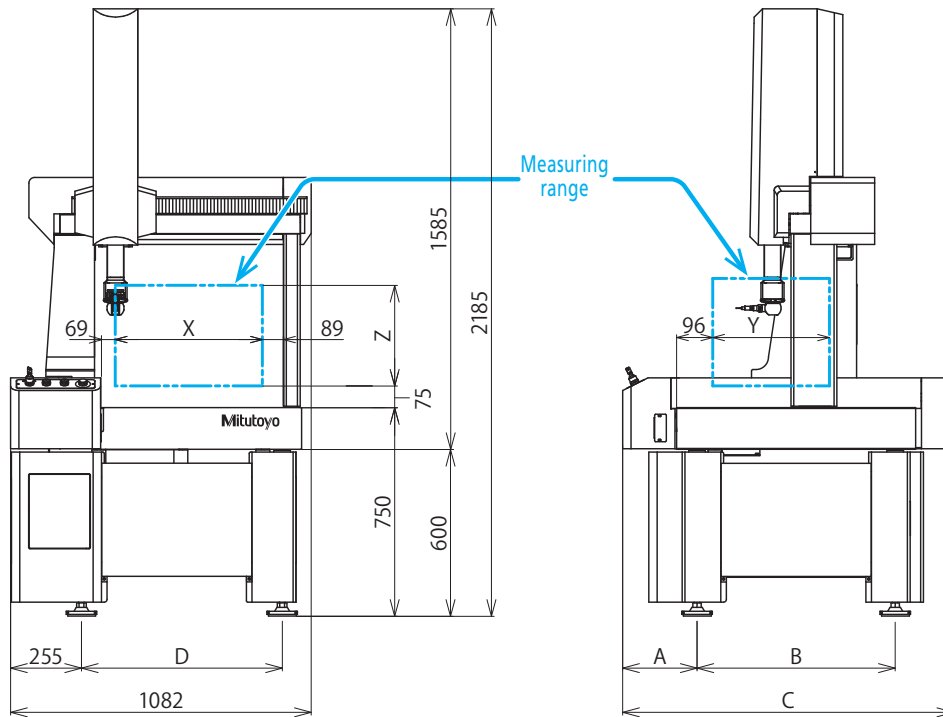

Stand and Vibration isolating stand specifications

Model	CRYSTA-Apex V PLUS544		CRYSTA-Apex V PLUS574	
	Stand	Vibration isolating stand	Stand	Vibration isolating stand
X		500		
Y	400		700	
Z		400		
A	268	297	315	344
B	713	635	1013	935
C		1191		1548
D	722	710	722	710

Main unit specifications

		CRYSTA-Apex V PLUS776	CRYSTA-Apex V PLUS7106
Measuring range [mm]	X	700	
	Y	700	1000
	Z	600	
Guide method		Air bearing for each axis	
Drive speed [mm/s]	CNC MODE (Key selector switch: AUTO)	Each axis: Max. 300 (Max. combined speed: 519) Measuring speed: 1 - 8	
	CNC MODE (Key selector switch: MANUAL)	Each axis: Max. 138 (Max. combined speed: 239) Measuring speed: 1 - 8	
	J/S MODE	Drive speed: 0 - 80	
		Measuring speed: 0 - 3 Fine speed: 0 - 0.05	
Driving acceleration [mm/s ²]		Each axis: 1333 (Max. combined acceleration: 2309)	
Length measuring method		Linear encoder	
Resolution [mm]		0.0001	
Measuring table	Material	Granite	
	Size (load surface) [mm]	880x1420	880x1720
	Workpiece fixing method	M8x1.25	
Workpiece	Maximum height [mm]	800	
	Maximum mass [kg]	800	1000
Main unit key dimensions [mm]	Height	2730	
	Width	1470	
	Depth	1700	2000
Machine mass [kg] (including controller, excluding workpiece)	Stand	1810	2063
	Vibration isolating stand	1881	2147
Power supply	Voltage, Frequency		100-120/200-240 VAC ±10 %, 50/60 Hz
	Power consumption [kW]	Standard (PH10MQ + TP200)	Max.: 0.46, Avg.: 0.17
		With full options	Max.: 1.5
Air usage conditions	Air pressure used		0.4 MPa (4 kgf/cm ²)
	Air consumption		60 L/min (under standard conditions) (Air source: 120 L/min)
Operating temperature		10 to 35 °C	

Accuracy specifications

Probe configuration	Probe	TP20	TP200	SP25M		SP80*1	MPP-310Q *1	PH20 *2 + TP20
	Module			SM25-1 SH25-1	SM25-2 SH25-2			
Maximum permissible error of length measurement $E_{0,MPE}$ [μ m]	Temperature environment 1 *3	2.3 + 3L/1000	2.0 + 3L/1000	1.8 + 3L/1000	1.9 + 3L/1000	1.8 + 3L/1000	1.8 + 3L/1000	2.3 + 3L/1000
	Temperature environment 2 *3	2.3 + 4L/1000	2.0 + 4L/1000	1.8 + 4L/1000	1.9 + 4L/1000	1.8 + 4L/1000	1.8 + 4L/1000	2.3 + 4L/1000
	Temperature environment 3 *3	2.3 + 5L/1000	2.0 + 5L/1000	1.8 + 5L/1000	1.9 + 5L/1000	1.8 + 5L/1000	1.8 + 5L/1000	2.3 + 5L/1000
Maximum permissible error of length measurement $E_{150,MPE}$ [μ m]	Temperature environment 1 *3	2.8 + 3L/1000	2.5 + 3L/1000	1.8 + 3L/1000		1.8 + 3L/1000	1.8 + 3L/1000	
	Temperature environment 2 *3	2.8 + 4L/1000	2.5 + 4L/1000	1.8 + 4L/1000		1.8 + 4L/1000	1.8 + 4L/1000	
	Temperature environment 3 *3	2.8 + 5L/1000	2.5 + 5L/1000	2.3 + 5L/1000		2.3 + 5L/1000	2.3 + 5L/1000	
Maximum permissible error of length measurement $E_{200,MPE}$ [μ m]	Temperature environment 1 *3				2.0 + 3L/1000			
	Temperature environment 2 *3				2.0 + 4L/1000			
	Temperature environment 3 *3				2.5 + 5L/1000			
Maximum permissible limit of the repeatability range $R_{0,MPL}$ [μ m]		2.3	2.0	1.4	1.5	1.4	1.4	2.3
Maximum permissible scanning mode form error on a sphere $P_{Form,Sph,Scan,PP,Tact,MPE}$ [μ m]				2.4	2.5	2.1	1.9	
Maximum permissible scanning mode time $P_{Form,Sph,Scan,PP,Tact,MPE}$ [Sec]				50	50	50	80	
Maximum permissible single-stylus form error $P_{Form,Sph,1x25,SS,Tact,MPE}$ [μ m]		2.3	2.0	1.8	1.9	1.8	1.8	2.3

All accuracy specifications are based on use of a standard stylus. Standard stylus: TP20: ϕ 4x10, TP200: ϕ 4x10, SP25M: ϕ 4x50, SP80: ϕ 4x50, MPP-310Q: ϕ 4x18, PH20: ϕ 4x12

Accuracy specifications for scanning probes (SP25M, SP80, MPP-310Q) are based on high accuracy mode.

The $E_{0,MPE}$, $E_{150,MPE}$, $E_{200,MPE}$ and $R_{0,MPL}$ testing and evaluation methods comply with ISO 10360-2:2009 (JIS B 7440-2:2013).

The $P_{Form,Sph,Scan,PP,Tact,MPE}$ and $P_{Form,Sph,1x25,SS,Tact,MPE}$ testing and evaluation methods comply with ISO 10360-5:2020 (JIS B 7440-5:2022).

L = given measurement length (unit): mm

*1: Requires custom-made main unit.

*2: For the probe system, accuracy is guaranteed using CMM touch measurement. However, $E_{150,MPE}$ and $E_{200,MPE}$ are not guaranteed. Additionally, accuracy may decrease if the length or mass is increased by using a stylus extension or a non-standard stylus.

*3: For temperature environments 1 to 3, refer to "Temperature environment", below.

Temperature environment

		Temperature environment 1	Temperature environment 2	Temperature environment 3
Accuracy guaranteed temperature	Temperature range	18 to 22 °C	16 to 26 °C	15 to 30 °C
	Temperature change	2 °C in 1 hour 2 °C in 24 hours	2 °C in 1 hour 5 °C in 24 hours	
	Temperature gradient	1 °C per 1 m (both vertically and horizontally)		

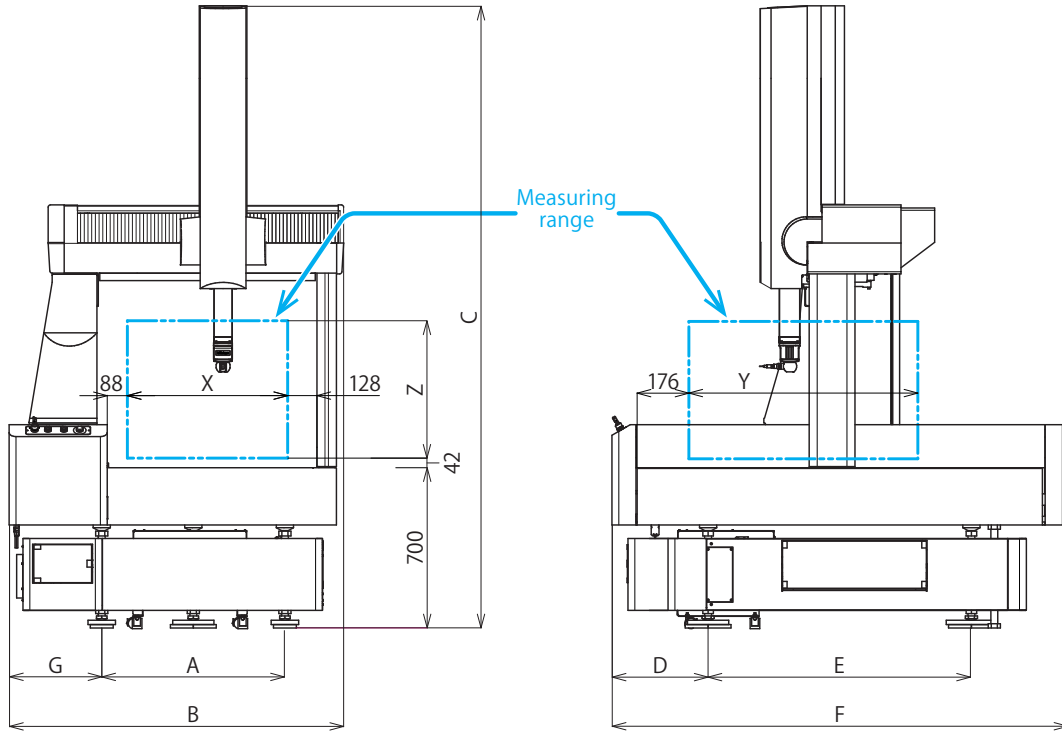

Stand and Vibration isolating stand specifications

Model	CRYSTA-Apex V PLUS776		CRYSTA-Apex V PLUS7106	
	Stand	Vibration isolating stand	Stand	Vibration isolating stand
X	700			
Y	700		1000	
Z	600			
A	800	870	800	870
B	1470			
C	2730			
D	470	458	520	458
E	800	865	1000	1115
F	1700		2000	
G	405	305	405	305

Main unit specifications

		CRYSTA-Apex V PLUS9106	CRYSTA-Apex V PLUS9166	CRYSTA-Apex V PLUS9206	CRYSTA-Apex V PLUS9108	CRYSTA-Apex V PLUS9168	CRYSTA-Apex V PLUS9208
Measuring range [mm]	X	900					
	Y	1000	1600	2000	1000	1600	2000
	Z	600			800		
Guide method		Air bearing for each axis					
Drive speed [mm/s]	CNC MODE (Key selector switch: AUTO)	Each axis: Max. 300 (Max. combined speed: 519)					
		Measuring speed: 1 - 8			Measuring speed: 1 - 3		
	CNC MODE (Key selector switch: MANUAL)	Each axis: Max. 138 (Max. combined speed: 239)					
		Measuring speed: 1 - 8			Measuring speed: 1 - 3		
J/S MODE	Drive speed: 0 - 80						
	Measuring speed: 0 - 3						
	Fine speed: 0 - 0.05						
Driving acceleration [mm/s ²]		Each axis: 1333 (Max. combined acceleration: 2309)			Each axis: 1000 (Max. combined acceleration: 1732)		
Length measuring method		Linear encoder					
Resolution [mm]		0.0001					
Measuring table	Material	Granite					
	Size (load surface) [mm]	1080×1720	1080×2320	1080×2720	1080×1720	1080×2320	1080×2720
	Workpiece fixing method	M8×1.25					
Workpiece	Maximum height [mm]	800			1000		
	Maximum mass [kg]	1200	1500	1800	1200	1500	1800
Main unit key dimensions [mm]	Height	2730					
	Width	1670					
	Depth	2000	2740	3220	2000	2740	3220
Machine mass [kg] (including controller, excluding workpiece)	Stand	2267	2969	4052	2287	2999	4082
	Vibration isolating stand	2381	3072	4235	2401	3102	4265
Power supply	Voltage, Frequency		100-120/200-240 VAC ±10 %, 50/60 Hz				
	Power consumption [kW]	Standard (PH10MQ + TP200)	Max.: 0.47, Avg.: 0.17				
		With full options	Max.: 1.5				
Air usage conditions	Air pressure used	0.4 MPa (4 kgf/cm ²)					
	Air consumption	60 L/min (under standard conditions) (Air source: 120 L/min)					
Operating temperature		10 to 35 °C					

Accuracy specifications

Probe configuration	Probe	TP20	TP200	SP25M		SP80*1	MPP-310Q *1	PH20 *2 + TP20
	Module			SM25-1 SH25-1	SM25-2 SH25-2			
Maximum permissible error of length measurement $E_{0,MPE}$ [μm]	Temperature environment 1 ⁴³	2.3 + 3L/1000	2.0 + 3L/1000	1.8 + 3L/1000	1.9 + 3L/1000	1.8 + 3L/1000	1.8 + 3L/1000	2.3 + 3L/1000
	Temperature environment 2 ⁴³	2.3 + 4L/1000	2.0 + 4L/1000	1.8 + 4L/1000	1.9 + 4L/1000	1.8 + 4L/1000	1.8 + 4L/1000	2.3 + 4L/1000
	Temperature environment 3 ⁴³ (Z600 mm model)	2.3 + 5L/1000	2.0 + 5L/1000	1.8 + 5L/1000	1.9 + 5L/1000	1.8 + 5L/1000	1.8 + 5L/1000	2.3 + 5L/1000
	Temperature environment 3 ⁴³ (Z800 mm model)	2.3 + 6.5L/1000	2.0 + 6.5L/1000	1.8 + 6.5L/1000	1.9 + 6.5L/1000	1.8 + 6.5L/1000	1.8 + 6.5L/1000	2.3 + 6.5L/1000
Maximum permissible error of length measurement $E_{150,MPE}$ [μm]	Temperature environment 1 ⁴³	2.8 + 3L/1000	2.5 + 3L/1000	1.8 + 3L/1000		1.8 + 3L/1000	1.8 + 3L/1000	
	Temperature environment 2 ⁴³	2.8 + 4L/1000	2.5 + 4L/1000	1.8 + 4L/1000		1.8 + 4L/1000	1.8 + 4L/1000	
	Temperature environment 3 ⁴³ (Z600 mm model)	2.8 + 5L/1000	2.5 + 5L/1000	2.3 + 5L/1000		2.3 + 5L/1000	2.3 + 5L/1000	
	Temperature environment 3 ⁴³ (Z800 mm model)	2.8 + 6.5L/1000	2.5 + 6.5L/1000	2.3 + 6.5L/1000		2.3 + 6.5L/1000	2.3 + 6.5L/1000	
Maximum permissible error of length measurement $E_{200,MPE}$ [μm]	Temperature environment 1 ⁴³				2.0 + 3L/1000			
	Temperature environment 2 ⁴³				2.0 + 4L/1000			
	Temperature environment 3 ⁴³ (Z600 mm model)				2.5 + 5L/1000			
	Temperature environment 3 ⁴³ (Z800 mm model)				2.5 + 6.5L/1000			
Maximum permissible limit of the repeatability range $R_{0,MPL}$ [μm]		2.3	2.0	1.4	1.5	1.4	1.4	2.3
Maximum permissible scanning mode form error on a sphere $P_{Form,Sph,Scan,PP,Tact,MPE}$ [μm]	Z600 mm model			2.4	2.5	2.1	1.9	
	Z800 mm model			2.4	2.5	2.4	1.9	
Maximum permissible scanning mode time $P_{Form,Sph,Scan,PP,Tact,MPL}$ [Sec]	Z600 mm model			50	50	50	80	
	Z800 mm model			60	60	60	80	
Maximum permissible single-stylus form error $P_{Form,Sph,1x25,SS,Tact,MPE}$ [μm]		2.3	2.0	1.8	1.9	1.8	1.8	2.3

All accuracy specifications are based on use of a standard stylus. Standard stylus: TP20: ø4×10, TP200: ø4×50, SP25M: ø4×50, SP80: ø4×50, MPP-310Q: ø4×18, PH20: ø4×12

Accuracy specifications for scanning probes (SP25M, SP80, MPP-310Q) are based on high accuracy mode.

The $E_{0,MPE}$, $E_{150,MPE}$, $E_{200,MPE}$ and $R_{0,MPL}$ testing and evaluation methods comply with ISO 10360-2:2009 (JIS B 7440-2:2013).

The $P_{Form,Sph,Scan,PP,Tact,MPE}$ and $P_{Form,Sph,1x25,SS,Tact,MPE}$ testing and evaluation methods comply with ISO 10360-5:2020 (JIS B 7440-5:2022).

L = given measurement length (unit): mm

*1: Requires custom-made main unit.

*2: For the probe system, accuracy is guaranteed using CMM touch measurement. However, $E_{150,MPE}$ and $E_{200,MPE}$ are not guaranteed. Additionally, accuracy may decrease if the length or mass is increased by using a stylus extension or a non-standard stylus. For models with a Z stroke of 800, probe systems are not supported.

*3: For temperature environments 1 to 3, refer to "Temperature environment", below.

Temperature environment

		Temperature environment 1	Temperature environment 2	Temperature environment 3
Accuracy guaranteed temperature	Temperature range	18 to 22 °C	16 to 26 °C	15 to 30 °C
	Temperature change	2 °C in 1 hour 2 °C in 24 hours	2 °C in 1 hour 5 °C in 24 hours	
	Temperature gradient	1 °C per 1 m (both vertically and horizontally)		

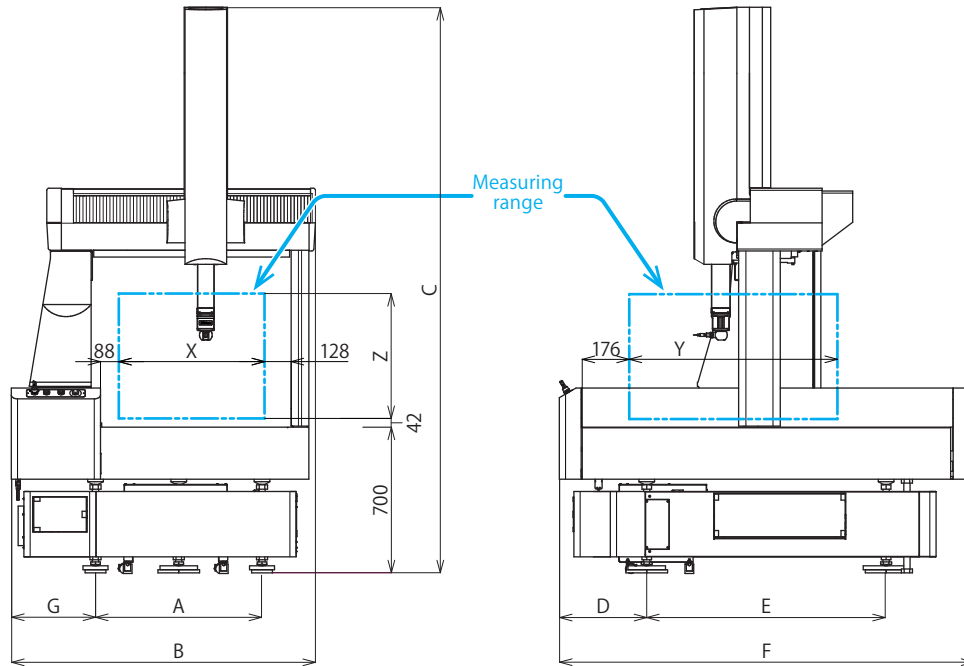

Stand specifications

Model	CRYSTA-Apex V PLUS9106	CRYSTA-Apex V PLUS9166	CRYSTA-Apex V PLUS9206	CRYSTA-Apex V PLUS9108	CRYSTA-Apex V PLUS9168	CRYSTA-Apex V PLUS9208
X	900					
Y	1000	1600	2000	1000	1600	2000
Z	600		800			
A	1000					
B	1670					
C	2730			3130		
D	520	750	823	520	750	880
E	1000	1320	1500	1000	1320	1500
F	2000	2740	3220	2000	2740	3220
G	405					

Vibration isolating stand specifications

Model	CRYSTA-Apex V PLUS9106	CRYSTA-Apex V PLUS9166	CRYSTA-Apex V PLUS9206	CRYSTA-Apex V PLUS9108	CRYSTA-Apex V PLUS9168	CRYSTA-Apex V PLUS9208
X	900					
Y	1000	1600	2000	1000	1600	2000
Z	600		800			
A	1030		995	1030		995
B	1670					
C	2730			3130		
D	478	683		478	683	823
E	1095	1410	1608	1095	1410	1608
F	2000	2740	3220	2000	2740	3220
G	325		335	325		335

Clamp hole arrangement on the measuring table

Unit: mm

CRYSTA-Apex V PLUS 500 Series

* Workpiece loading area
** Supporter traveling surface

CRYSTA-Apex V PLUS544

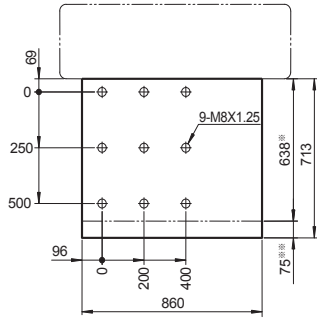

CRYSTA-Apex V PLUS574

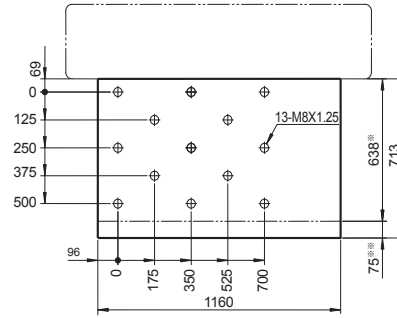

CRYSTA-Apex V PLUS 700 Series

CRYSTA-Apex V PLUS776

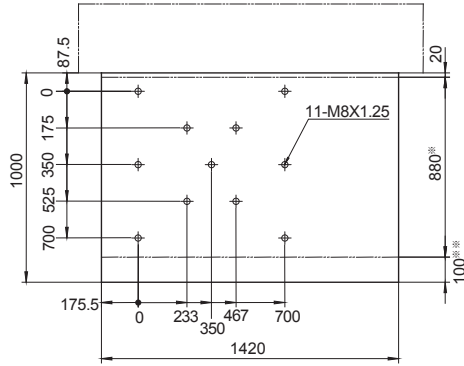

CRYSTA-Apex V PLUS7106

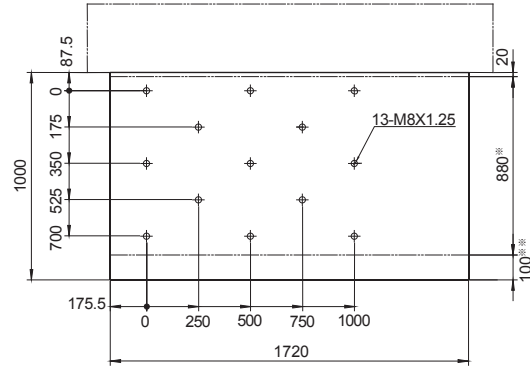

CRYSTA-Apex V PLUS 900 Series

CRYSTA-Apex V PLUS9106/9108

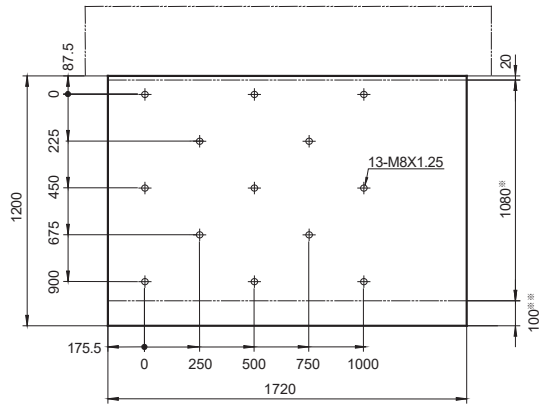

CRYSTA-Apex V PLUS9166/9168

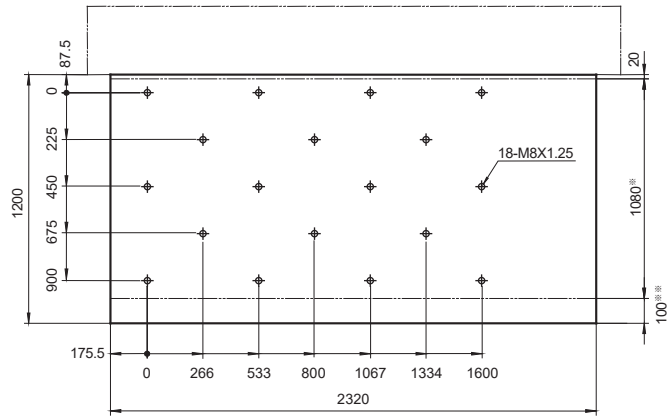

CRYSTA-Apex V PLUS9206/9208

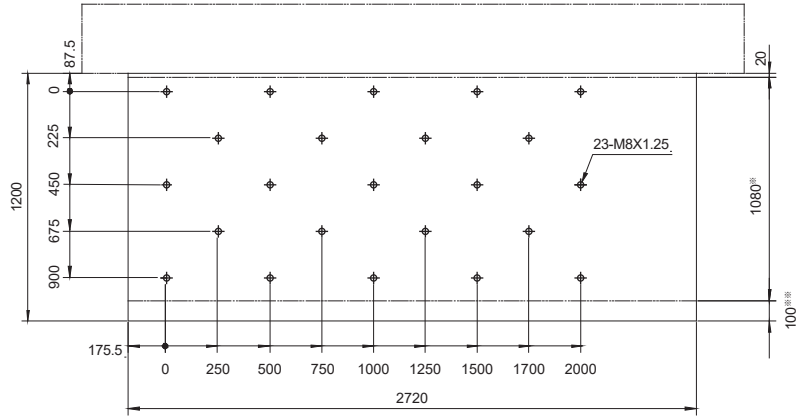

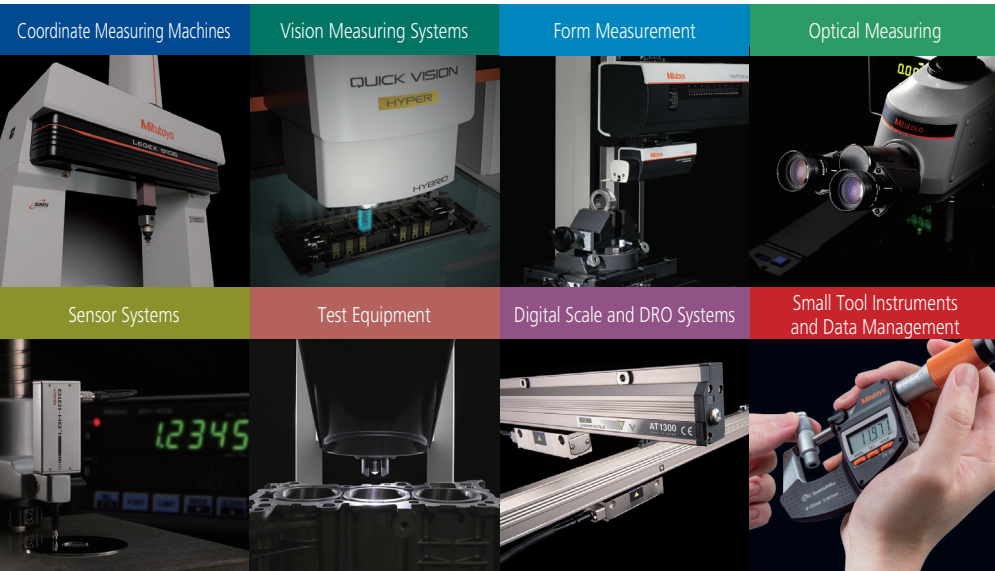

Whatever your challenges are, Mitutoyo supports you from start to finish.

Mitutoyo is not only a manufacturer of top quality measuring products but one that also offers qualified support for the lifetime of the equipment, backed up by comprehensive services that ensure your staff can make the very best use of the investment.

Apart from the basics of calibration and repair, Mitutoyo offers product and metrology training, as well as IT support for the sophisticated software used in modern measuring technology. We can also design, build, test and deliver measuring solutions and even, if deemed cost-effective, take your critical measurement challenges in-house on a sub-contract basis.



Find out more information by emailing by info@mitutoyo.ca

www.mitutoyo.ca

All information regarding our products, and in particular the illustrations, drawings, dimensional and performance data contained in this printed matter as well as other technical data are to be regarded as approximate average values. We reserve the right to make changes to the corresponding designs. The stated standards, technical regulations, descriptions and illustrations of the products were valid at the time of printing. In addition, the products are subject to Canadian Export Administration Regulations. Re-export or relocation of Mitutoyo products may require prior approval by an appropriate governing authority.

Trademarks and Registrations

Designations used by companies to distinguish their products are often claimed as trademarks. In all instances where Mitutoyo Canada Inc. is aware of a claim, the product names appear in initial capital or all capital letters. The appropriate companies should be contacted for more complete trademark and registration information.



EXPERIENCE MITUTOYO M3 SOLUTION CENTERS

Mississauga, ON
2121 Meadowvale Blvd.,
Mississauga, ON L5N 5N1
Tel. (905) 821-1261

Montréal, QC
5539 Ernest-Cormier Street,
Unit B, Laval, QC, H7C 2S9

www.mitutoyo.ca
info@mitutoyo.ca