

WINTER FLYER 2010

Mitutoyo

PRECISION TOOLS & INSTRUMENTS

Prices effective from Jan. 1 - Apr. 30, 2010 or while quantities last. Some items may not be exactly as shown.

QuantuMike Micrometer

SERIES 293 — For significant reduction in positioning time



LIGHTENING SPEED!

- Speedy measurement is achieved thanks to 2mm of spindle feed for every thimble revolution!
- The QuantuMike provides users with an excellent measuring experience with higher speed, quality and stability than ever before owing to the integration of sophisticated manufacturing and processing technologies.



Spindle feeds 4x faster than conventional micrometers!

SPC Cable Accessory
With Data Switch

Order No.	MSLP	SPECIAL
05CZA662 (1m)	\$100.00	\$90.00
05CZA663 (2m)	\$147.80	\$133.03

QuantuMike - Inch/Metric		Mitutoyo			
Range	Order No.	Resolution	MSLP	SPECIAL	ISO Calibration
0 - 1"	293-180	.00005"/0.001mm	\$343.00	\$308.70	\$35.00
0 - 1"	293-185*	.00005"/0.001mm	\$268.00	\$241.20	\$35.00
1" - 2"	293-181	.00005"/0.001mm	\$374.00	\$336.60	\$35.00
1" - 2"	293-186*	.00005"/0.001mm	\$316.00	\$284.40	\$35.00

*without SPC data output

ABSOLUTE Digimatic Caliper

SERIES 500 — with Exclusive ABSOLUTE Encoder Technology

- Large and clear LCD readout
- Absolute encoder keeps track of its origin point once set
- Zero-setting of the display is also possible at any slider position for easy comparison measurements (Incremental mode)
- 3.5 year battery life

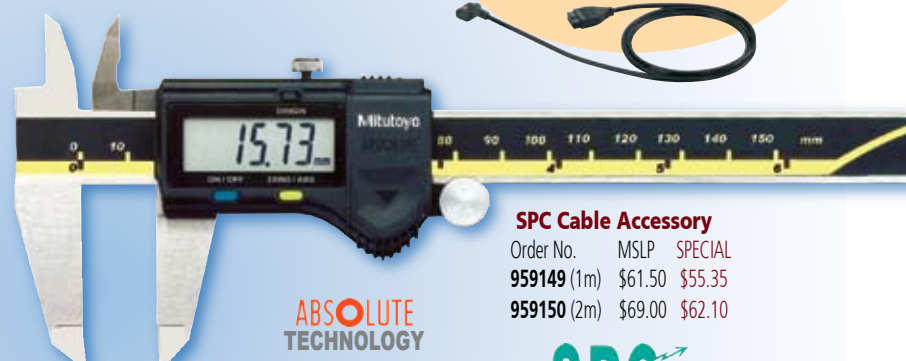

SPC Cable Accessory

Order No.	MSLP	SPECIAL
959149 (1m)	\$61.50	\$55.35
959150 (2m)	\$69.00	\$62.10

Digimatic Caliper - Inch/Metric		Mitutoyo			
Range	Order No.	Resolution	MSLP	SPECIAL	ISO Calibration
0 - 6"	500-196-20	.0005"/0.01mm	\$189.00	\$170.10	\$35.00
0 - 8"	500-197-20	.0005"/0.01mm	\$253.00	\$227.70	\$46.00
0 - 12"	500-193	.0005"/0.01mm	\$464.00	\$417.60	\$58.00

All calibrations are performed to ISO 17025 Standards

Digimatic Caliper - Inch/Metric		Mitutoyo			
Range	Order No.	Resolution	MSLP	SPECIAL	ISO Calibration
0 - 6"	500-171-20	.0005"/0.01mm	\$216.00	\$194.40	\$35.00
0 - 8"	500-172-20	.0005"/0.01mm	\$283.00	\$254.70	\$46.00
0 - 12"	500-173	.0005"/0.01mm	\$506.00	\$455.40	\$58.00
0 - 24"	500-506-10	.0005"/0.01mm	\$1,030.00	\$927.00	\$104.00



Magnetic Stand & Indicator Set

SERIES 7 — with Custom Tool Case

- Popular tool kit with indicator and magnetic stand
- Durable storage case with moulded tool bed

Tool Kit		Mitutoyo		
Order No.	Remarks	MSLP	SPECIAL	ISO Calibration
7046PCK	2416S Dial Indicator (range of 1" with .001" graduation) 7010SN Magnetic Stand	\$206.00	\$185.40	\$35.00 (Indicator only)

Dial Test Indicator

SERIES 513 — Quick Set Horizontal Type

- No-clutch structure for automatic reversal of measuring direction
- Flat crystal face is glare-free with scratch-resistant coating
- Jeweled bearings, Anti-magnetic
- Carbide contact point



513-402

Mitutoyo

Test Indicator - Inch

Range	Order No.	Graduation	Remarks	Dial	MSLP	SPECIAL	ISO Calibration
.03"	513-402	.0005"	Basic Set	0-15-0	\$119.00	\$107.10	\$35.00
.03"	513-402T	.0005"	Full Set	0-15-0	\$172.00	\$154.80	\$35.00
.008"	513-403	.0001"	Basic Set	0-4-0	\$148.00	\$133.20	\$35.00
.008"	513-403T	.0001"	Full Set	0-4-0	\$230.00	\$207.00	\$35.00

Dial Indicator

SERIES 2 — Scratch resistant

- With limit pins and an outer frame clamp
- The outer clamp and lifting lever (optional) can be attached to either the right or left side.
- Water/oil resistant, scratch resistant
- A carbide contact point is used
- ANSI Standard (3/8" Stem dia.)
- 0-100 dial



Mitutoyo

Dial Indicator - Inch

Range	Graduation	Order No.	Range per Rev.	MSLP	SPECIAL	ISO Calibration
1"	.001"	24165	.1"	\$112.00	\$100.80	\$35.00
1"	.001"	24165-10*	.1"	\$129.00	\$116.10	\$35.00

*jeweled bearings

Indicator Stands

SERIES 7 — with Permanent Magnet

- Accepts all dial indicators and dial test indicators
- On/Off switch for instant mounting and dismounting without any adverse effect to the indicator or workpiece



7010SN

Mitutoyo

Magnetic Stands

Description	Order No.	MSLP	SPECIAL
6" rod & universal clamp	7010SN	\$93.00	\$83.70
6" rod & fine adjustment	7011SN	\$105.00	\$94.50

Lots of optional accessories to choose from: contact points, backs, spindle lifting lever, etc

Digimatic Indicator

SERIES 543 — with ABSOLUTE Technology



- ABSOLUTE encoder technology eliminates over-speed errors
- SPC data output
- Origin-Set, Zero-set, Counting direction switching, Power On/Off, Data output, Inch/mm conversion, Low voltage alarm, Counting, value composition error, Overflow error
- ANSI Standard (Stem dia. 3/8")

SPC Cable Accessory

Order No.	MSLP	SPECIAL
905338 (1m)	\$46.30	\$41.67
905409 (2m)	\$51.00	\$45.90



Digimatic Indicator - Inch/Metric

Range	Resolution	Order No.	Back	MSLP	SPECIAL	ISO Calibration
0 - .5"	.0005"/0.01mm	543-683	Lug	\$194.00	\$174.60	\$35.00
0 - .5"	.0005"/0.01mm	543-683B	Flat	\$194.00	\$174.60	\$35.00

Mitutoyo

Dial Caliper

SERIES 505 — with Titanium Coating

- Smooth sliding and high shock protection
- Titanium coating is applied to the sliding surface

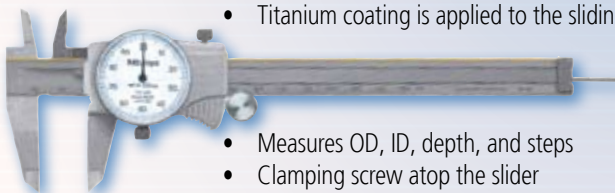

- Measures OD, ID, depth, and steps
- Clamping screw atop the slider

Dial Caliper - Inch

Mitutoyo

Range	Order No.	Graduation	Range/Rev.	MSLP	SPECIAL	ISO Calibration
0 - 6"	505-675	.001"	.10"	\$148.00	\$133.20	\$35.00
0 - 8"	505-676	.001"	.10"	\$205.00	\$184.50	\$46.00
0 - 8"	505-690*	.001"	.10"	\$230.00	\$207.00	\$46.00
0 - 12"	505-677**	.001"	.10"	\$346.00	\$311.40	\$58.00

* Extra smooth movement type **No Titanium coating on 12" models

Vernier Caliper

SERIES 530 — Standard Model

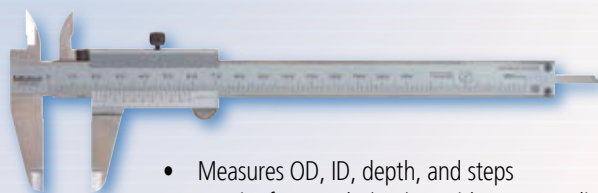

- Measures OD, ID, depth, and steps
- Vernier face angle (14°) provides easy reading
- Inch/Inch dual scale
- Clamping screw atop the slider

Vernier Caliper - Inch

Mitutoyo

Order No.	Range	Vernier Graduation		MSLP	SPECIAL	ISO Calibration
		Lower	Upper			
530-105	0 - 6"	.001"	1/128"	\$89.00	\$80.10	\$35.00
530-116	0 - 8"	.001"	1/128"	\$122.00	\$109.80	\$46.00

Outside Micrometer

SERIES 103 — Ratchet Stop

- Positive locking clamp
- Models over 1" come with standard
- Carbide measuring faces



Outside Micrometer - Inch

Range	Order No.	Graduation	MSLP	SPECIAL	ISO Calibration
0 - 1"	103-177	.001"	\$91.00	\$81.90	\$35.00
1 - 2"	103-178	.001"	\$105.00	\$94.50	\$35.00
2 - 3"	103-179	.001"	\$130.00	\$117.00	\$35.00
3 - 4"	103-180	.001"	\$147.00	\$132.30	\$35.00
4 - 5"	103-181	.001"	\$157.00	\$141.30	\$35.00

Mitutoyo

All Mitutoyo micrometers have **CARBIDE TIPPED** measuring faces

Outside Micrometer Sets

SERIES 103 — With Standards

- Baked-enamel-finished frame
- Positive locking clamp
- Complete with storage case
- Clear graduations on satin-chrome finish
- Carbide measuring faces
- Includes micrometer standards (except for 0-1" models)



Micrometer Sets - Inch

Range	Order No.	Graduation	MSLP	SPECIAL	ISO Calibration
0 - 3" (3 pc./set)	103-922	.0001"	\$396.00	\$356.40	\$105.00
0 - 6" (6 pc./set)	103-907-01	.0001"	\$904.00	\$813.60	\$355.00

Mitutoyo

Depth Micrometer

SERIES 129 — Interchangeable Rods

- ø.157" interchangeable rods provide a wide measuring range
- The rod length can be adjusted with two supplied wrenches to compensate wear on the measuring tip
- With ratchet stop for constant force

Micrometer Stand

Adjustable Angle Type
Order No. 156-101
SPECIAL \$81.90
MSLP \$91.00



Mitutoyo

Depth Micrometer - Inch

Range	Order No.	Graduation	Base	Rods	MSLP	SPECIAL	ISO Calibration
0 - 4"	129-127	.001"	2.5"	4	\$190.00	\$171.00	\$104.00
0 - 6"	129-128	.001"	2.5"	6	\$242.00	\$217.80	\$138.00
0 - 4"	129-131	.001"	4.0"	4	\$211.00	\$189.90	\$104.00
0 - 6"	129-132	.001"	4.0"	6	\$257.00	\$231.30	\$138.00
0 - 12"	129-150	.001"	4.0"	12	\$405.00	\$364.50	\$138.00

Digimatic "Lite" Micrometer

SERIES 293 — Economy Design

- Provided with basic functions (inch/metric key and zero-set key)
- A ratchet stop or friction thimble
- Large LCD characters



"Lite" Micrometer - Inch/Metric

Range	Order No.	Resolution	Type	MSLP	SPECIAL	ISO Calibration
0 - 1"	293-831	.00005"/0.001mm	Ratchet Stop	\$164.00	\$147.60	\$35.00
0 - 1"	293-832	.00005"/0.001mm	Friction thimble	\$168.00	\$151.20	\$35.00

Mitutoyo

Tubular Inside Micrometer

SERIES 137 — Extension Rod Type

- Wide range of ID measurements by combining extension rods (pipes) and anvils with the micrometer head.
- With 137-002 Micrometer head (.50" travel and .001" resolution)



Tubular Inside Micrometer - Inch

Range	Order No.	Extension Rods	MSLP	SPECIAL	ISO Calibration
2 - 12"	137-212	.5", 1", 2" (2 pcs.), 4"	\$376.00	\$338.40	\$104.00
2 - 40"	137-214	.5", 1", 2" (2 pcs.), 4", 8" (2 pcs.), 12"	\$605.00	\$544.50	\$104.00

Mitutoyo

Digimatic Micrometer Head

SERIES 164 — IP65 Protection Rating

- Non-rotating device provides no radial torsion on the workpiece surface so that workpiece wear and deformation are minimized
- Functions include Preset, Zero-set, Data hold, Data output, +/- conversion, inch/mm
- Excellent environmental protection
- Spindle face is flat (carbide tip)



SPC Cable Accessory

Order No.	MSLP	SPECIAL
937387 (1m)	\$60.00	\$54.00
965013 (2m)	\$96.00	\$86.40



Digimatic Mic Head - Inch/Metric

Range	Order No.	Resolution	MSLP	SPECIAL	ISO Calibration
0 - 2"	164-162	.00005"/0.001mm	\$1,040.00	\$936.00	\$69.00

Mitutoyo

Telescoping Gauge Set

SERIES 155 — Spring Loaded

- Spring-loaded plunger expands within the bore or groove, allowing determination of the internal diameter
- With a knurled clamp



Telescoping Gauge - Inch

Mitutoyo

Total range	Order No.	MSLP	SPECIAL
.313" - .50"	155-121	\$36.00	\$32.40
1.25" - 2.125"	155-124	\$39.00	\$35.10
.313" - 6.0"	155-903 (Set of 6)	\$232.00	\$208.80

Steel Rules

Series 182 — Full Flexible Rules

- Clear graduations on satin-chrome finish
- Stainless tempered
- Width 1/2", Thickness 1/64"

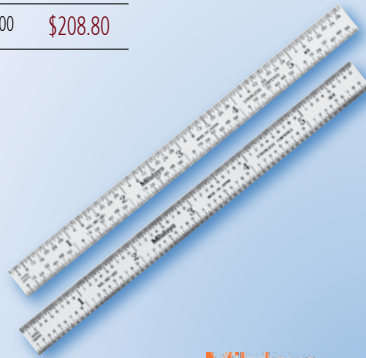

Full Flexible Steel Rules

Mitutoyo

Range	Reading	Order No.	Graduations	MSLP	SPECIAL
6" x 150mm	Inch/mm	182-205	1/32, 1/64", 1mm, 0.5mm	\$16.00	\$14.40
6" x 150mm	Inch/mm	182-206	1/50", 1/100", 1mm, 0.5mm	\$16.00	\$14.40
6" x 150mm	Inch/mm	182-207	1/10", 1/100", 1mm, 0.5mm	\$16.00	\$14.40
6" x 150mm	Inch/mm	182-208	1/10", 1/50", 1mm, 0.5mm	\$24.00	\$21.60
6" (3R)	Inch	182-204	1/32", 1/64", 1/10", 1/50	\$16.00	\$14.40
6" (4R)	Inch	182-201	1/8", 1/16", 1/32", 1/64"	\$16.00	\$14.40
6" (16R)	Inch	182-202	1/32", 1/64", 1/50", 1/100"	\$16.00	\$14.40
6" (5R)	Inch	182-203	1/32", 1/64", 1/10", 1/100"	\$16.00	\$14.40

Radius Gauges

- Size is stamped on each gauge
- Both concave and convex radius gauges become a pair
- With locking clamp



186-102



186-901

Radius Gauges

Mitutoyo

Range	Order No.	No. leaves	MSLP	SPECIAL
1/32" - 1/4"	186-101	30	\$40.00	\$36.00
1/16" - 1/2"	186-102	32	\$46.00	\$41.40
1/64" - 17/64" by 64ths and 9/32" - 1/2" by 32nds	186-901 (Set)	25	\$138.00	\$124.20

Combination Square Set

SERIES 180 — Inch Reading

- Three measuring heads are attached to the stainless steel rule (blade), allowing versatile measurements on various types of workpieces
- Inch reading

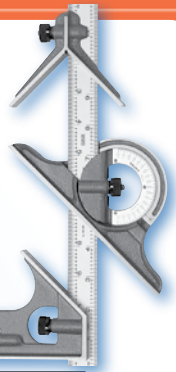

Combination Square Sets

Mitutoyo

Size	Order No.	Graduations	MSLP	SPECIAL
12" (4R)	180-905*	8, 16, 32, 64ths	Inch \$223.00	\$200.70
12" (4R)	180-805	8, 16, 32, 64ths	Inch \$211.00	\$189.90
12"/300mm	180-907*	32, 64ths, 1, 0.5mm	Inch /mm \$228.00	\$205.20

*Hardened cast iron heads

Dial Thickness Gauge

Series 7 — Standard, Ceramic Spindle/Anvil

- For quick and efficient inspection
- Convenient grip handle, thumb trigger and spring loaded spindle
- ANSI Group 2 dial indicator with 3/8" stem dia.
- Measuring Force 1.5N or less



Dial Thickness Gauge- Inch

Mitutoyo

Order No.	Range	Graduation	MSLP	SPECIAL	ISO Calibration
7300S	0 - .5"	.001"	\$142.00	\$127.80	\$46.00

Dial Bore Gauge

Series 511 — with Interchangeable anvils

- Complete with 2923SB-10 dial indicator (graduation .0001")
- Dial indicator is fully protected by a rugged cover
- Carbide-tipped contact point for durability
- A digimatic indicator can be attached in place of the dial gauge
- Optional extension rods can be attached for measuring deeper holes



511-164

Bore Gauge with 2923SB-10 Indicator - Inch

Mitutoyo

Range	Order No.	Anvils	Spacers	MSLP	SPECIAL	ISO Calibration
.7" - 1.4"	511-163	8	3	\$420.00	\$378.00	\$81.00
1.4" - 2.5"	511-164	6	4	\$413.00	\$371.70	\$81.00
2" - 6"	511-166	11 & 2" sub-anvil	4	\$453.00	\$407.70	\$81.00

Digital Readout Packages

With ABSOLUTE Digital Readout Linear Scales & KA Counter

*DRO Packages Include:

- KA Counter (2-Axis)
- KA Counter Tray/arm kit
- AT715 ABSOLUTE scales (2)
- Bracket Kit
- Extension cable (if scale is over 36"/900mm)



KA COUNTER FEATURES

- Bolt Hole Circle Calculation
- Diameter Display and Tool Offsets (Parameter mode)
- Memory compensation value
- Selecting Coordinates 0 to 10
- Preset
- Zero Approach Machining
- Pitch Approach Machining
- 1/2 Calculation
- Inch/mm
- Standard Resolution: .001"/.0005"/.0002"/.0001"/.00005" (0.01mm/0.005mm/0.002mm/0.001mm): When connecting AT715
- .002"/.0010"/.0005"/.0004"/.0002"/.0002" (0.020mm/0.010mm/0.004mm/0.002mm): When connecting AT715 Series (DIA.)

Mitutoyo DRO packages

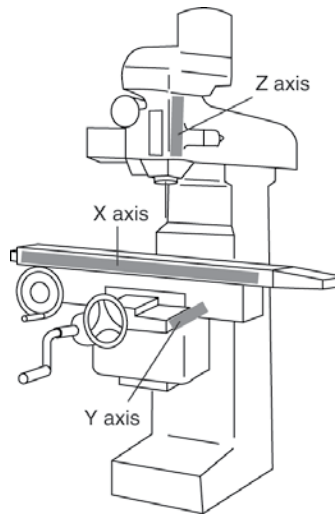

The perfect combination for all your milling machine applications.

Save when you buy a package PLUS an extra 10% WINTER VALUE SAVINGS

High Performance and affordable prices.

Using Electromagnetic Induction Detection with improved reliability and contamination protection - rated IP67 for dust and water.



ABSOLUTE TECHNOLOGY

True Absolute scale technology means original part datum point is never lost, even when power is off.

SAVE \$\$

Take advantage of our great PACKAGE PRICING!

DRO PACKAGES*

Order No.	Travel	MSLP Pkg.	PKG. SPECIAL
D950-989	12 x 30"	\$1,530.00	\$1,377.00
<i>(Compare -if ordered separately \$1,695.00)</i>			
D950-991	12 x 26"	\$1,555.00	\$1,399.50
<i>(Compare -if ordered separately \$1,728.00)</i>			
D950-990	14 x 30"	\$1,530.00	\$1,377.00
<i>(Compare -if ordered separately \$1,693.00)</i>			
D950-992	16 x 36"	\$1,555.00	\$1,399.50
<i>(Compare -if ordered separately \$1,730.00)</i>			

ABSOLUTE Digimatic Height Gauge

Series 570 — with ABSOLUTE Linear Encoder

- Built-in ABSOLUTE linear encoder for direct measurement from power on. No over-speed error for improved reliability
- Rigid column structure ensures high measuring accuracy
- Large smooth slider feed wheel
- Carbide-tipped scriber is provided
- With SPC data output
- Functions include Zero-setting, (ABS and INC modes), Presetting (ABS and INC modes), Hold/Data button, Inch/mm conversion, Error alarm, low battery alarm, On/Off, Origin

ABSOLUTE TECHNOLOGY

SPC Cable Accessory

Order No.	MSLP	SPECIAL
905338 (1m)	\$46.30	\$41.67
905409 (2m)	\$51.00	\$45.90



Holtest

Series 368 — Three Point Internal Micrometer

- Three contact points made of alloyed steel
- Measurement can be taken closer to the bottom of the bond bore
- Can measure deep holes (using extension rod)
- Ratchet stop
- .65" DIA. Setting Ring and Extension rod included
- Individual ranges: .5"-.65", .65"-.8"
- Graduation .0002"



Digimatic Height Gauge - Inch/Metric

Range	Order No.	Resolution	MSLP	SPECIAL	ISO Calibration
0 - 12"	570-312	.0005"/0.01mm	\$716.00	\$644.40	\$69.00
0 - 18"	570-313	.0005"/0.01mm	\$979.00	\$881.10	\$104.00
0 - 24"	570-314	.0005"/0.01mm	\$1,316.00	\$1,184.40	\$127.00

Mitutoyo

Holtest - Inch

Range	Order No.	MSLP	SPECIAL	ISO Calibration
.5 - .8"	368-995	\$1,193.00	\$1,073.70	\$69.00

Mitutoyo

Roundtest RA-10

Roundness Measuring Instrument

FEATURES:

- Large and simple key layout
- Shop floor friendly unit needs only small installation space as its compact body integrates electronics and printer
- Rotary table with air bearings
- Rotational accuracy equivalent to higher priced models
- One-stroke Measurement Recall Function
- Zero-setting Function
- Wide selection of optional accessories
- Includes optional X-axis stop and Z-axis scale unit



Order No. 211-601A

with optional X-axis stop and Z-axis scale unit
MSLP \$13,330.00

SPECIAL \$11,997.00

ISO 17025 Calibration Included*

Optional Accessories RA-10

Order No.	Description	MSLP	SPECIAL
211-032	Quick chuck (OD: 1 - 79mm, ID: 25 - 69mm)*	\$2,410.00	\$2,169.00
211-031	Micro-chuck (OD: 1.5mm max.)*	\$1,859.00	\$1,673.10
12AAH426	Alignment table with DAT function (inch/mm)	\$3,800.00	\$3,420.00
211-052	Quick chuck (OD: 1 - 79mm, ID: 16 - 69mm)	\$2,150.00	\$1,935.00

*Can be installed on the alignment table (12AAH425 / 426 / 427) only.



211-052



211-055



211-032



211-031

QM-Height Series

World standard in height measurement

FEATURES:

- Excellent accuracy of $\pm(2.8+5L/1000) \mu\text{m}$
- Measures maximum/minimum and displacement from the surface or by increment
- Measures inside/outside diameter
- All measurements can be saved and recalled after measurement

0-24" Range

Order No 518-227

MSLP \$4,150.00

SPECIAL \$3,735.00

ISO 17025 Calibration:

Add \$127.00

Optional Accessories QM/LH

Order No.	Description	MSLP
12AAC072	Depth Probe	\$184.00

Many more probe accessories available!

SPECIAL \$165.60



12AAC072

Linear Height LH-600D

Power Grip Handle

FEATURES:

- Extreme accuracy of $\pm(1.1+0.6L/600) \mu\text{m}$
- Cost effective and ergonomic multi-functional design
- Large optional battery pack and many probe options for measurement flexibility
- Makes 2D measurement straightforward and accurate
- Sequential key operations for frequently used measurements
- The touch of a single key automatically runs the instrument until the last result is displayed

0-24" Range

Order No 518-342A-21

MSLP \$6,500.00

SPECIAL \$5,850.00

ISO 17025 Calibration:

Add \$390.00

TM-510 Microscope

Compact Toolmaker's Microscope with Digimatic Micrometer Heads

FEATURES:

- Well suited for measuring dimensions and angles of machined metals
- Check shapes of screws, gears by attaching optional reticle
- Easy angle measurements
- Illumination intensity adjustment



TM-510 (4 x 2" Stage)

Order No 176-809A

MSLP \$7,780.00

SPECIAL \$7,002.00

ISO 17025 Calibration:

Add \$250.00*

Two digimatic Micrometer Heads included. See pg. 3 for detailed description.



Angle reading

*Travel related expenses extra

PJ-A3010F-200

Vertical Profile Projector

FEATURES:

- Medium size vertical profile projector XY range 8 x 4". Maximum workpiece height 3.64"
- High versatility and easy operation
- XY counter is located near the projection screen to minimize eye movement
- Digital readout protractor screen facilitates angle measurement

PJ-A3010F-200 Profile Projector

Order No.	Description	MSLP	SPECIAL
302-711A	PJ-A3010F-200 with Standard Accessories	\$13,674.00	\$12,306.60

ISO 17025 Calibration Included*



QM-Data 200 Processor with Arm Mount

- Graphic display screen
- Programmable
- Full 2D coordinate measurement capability



Optional Accessories PJ-A3010F-200

Order No.	Description	MSLP	SPECIAL
176-107	Holder with clamp (Max. workpiece dia. 35mm)	\$177.00	\$159.30
932105	Overlay Chart (Set of 12)	\$985.00	\$886.50
264-146A	QM-Data 200 (Arm mount)	\$2,978.00	\$2,680.20

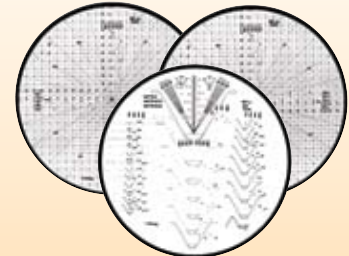

Overlay Charts

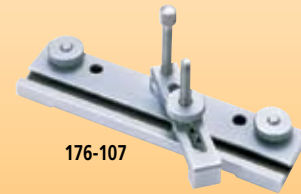

176-107

PH-3515F Profile Projector

Bench-Top Model with Erect Image

FEATURES:

- Suitable for thread pitch measurements - no blurred or distorted images when workpiece is angled
- 14" diameter protractor screen with cross-hairs and staggered lines for easy alignment
- Heavy duty workpiece table incorporates linear scales for fast, accurate measurement (XY travel 10" x 6")
- Heavy duty workpiece table incorporates linear scales for measuring speed and accuracy
- Erect image on day-bright screen
- Digital angle measurement to 1' or 0.01°



Optional Accessories PH-3515F

Order No.	Description	MSLP	SPECIAL
172-378	V-Block with clamp (max. workpiece dia. 25mm)	\$400.00	\$360.00
932105	Overlay Chart (Set of 12)	\$985.00	\$866.50
050002-L	Machine stand with casters	\$2,257.00	\$2,031.30
Fixture and Stage accessories			
172-143	Center support riser	\$375.00	\$337.50
172-144	Rotary vise (Max. workpiece dia.: 60mm)	\$605.00	\$544.50

PH-3515F Projector Packages

Order No.	Description/Travel	MSLP	SPECIAL
M172848-1	PH-3515F with 2-Axis KA Counter & Tray, 10X Lens	\$12,171.00	\$10,953.90
M172848-2	PH-3515F with QM Data Processor & Arm mount, 10X Lens	\$14,304.00	\$12,873.60
M172848-3	PH-3515F with QM Data Processor & Arm mount, Optoeye Edge sensor, 10X Lens	\$15,812.00	\$14,230.80

ISO 17025 Calibration Included*

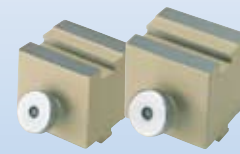

172-143



172-144



172-378

*Travel related expenses extra

U-WAVE Wireless System

Wireless Measurement Communication

The **U-WAVE** system enables easy wireless data communication from a measuring tool to a PC using the Digimatic protocol. Measurement efficiency is improved by eliminating the long and cumbersome data cables. The user friendly interface allows data to be loaded into any software product that accepts keyboard input, such as Excel or Notepad.

U-Wave-R (Receiver)

U-WAVE-R comes with set-up software, wall bracket and 1m cable. Connect up to 16 **U-WAVE-R** units to one PC.

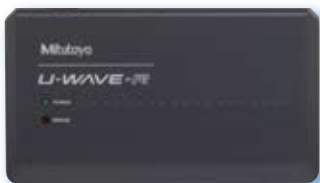

U-Wave-T (Transmitter)

U-WAVE-T (Buzzer type) sends measurement data to **U-WAVE-R**. Connect up to 100 U-WAVE-T units.



Manage and analyze data with **MeasurLink® Real Time Plus**

U-WAVE-T (Transmitter)

Transmits data from measuring tools to U-WAVE-R



U-WAVE-R (Receiver)

Loads data received from U-WAVE-T to PC software via USB port

Order No.	Description	MSLP	SPECIAL
02AZD810D	U-Wave-R	\$580.00	\$522.00
02AZD730D	U-Wave-T (IP67 type)	\$280.00	\$252.00
02AZD880D	U-Wave-T (Buzzer type)	\$280.00	\$252.00

U-WAVE dedicated Transmitter connection cable.

	Order No.	Applicable measuring instrument	MSLP	SPECIAL
A	02AZD790A	Water-proof CD	\$140.00	\$126.00
B	02AZD790B	Water-proof MDC	\$140.00	\$126.00
C	02AZD790C	CD-CX	\$140.00	\$126.00
D	02AZD790D	10 pin flat type	\$140.00	\$126.00
E	02AZD790E	6 pin round type	\$140.00	\$126.00
F	02AZD790F	Straight flat type	\$140.00	\$126.00
G	02AZD790G	ID-N/B	\$140.00	\$126.00

HOW TO ORDER U-WAVE:

1. One **U-Wave-R** required per system (supports up to 100 **U-Wave-T** units).
2. One **U-Wave-T** required for each digimatic Mitutoyo tool.
3. Select appropriate cable for each tool (connects measuring tool to **U-Wave-T**)

- Coordinate Measuring Machines
- Vision Measuring Systems
- Form Measurement
- Optical Measuring
- Sensor Systems
- Test Equipment and Seismometers
- Digital Scale and DRO Systems
- Small Tool Instruments and Data Management



MeasurLink® – Real Time Plus

Offers you all the SPC charting capabilities you require to improve your process control. See all your features charted on one page!

Order No. **64AAS802D**
SPECIAL \$1,252.80 MSLP \$1,392.00

Distributed by:

DURAMILL

INDUSTRIAL SUPPLIES INC.

21 Bradwick Dr., #2-3,
Concord, ON L4K 1K6

Concord: (905) 738-8665

Toronto: (416) 661-7809

Fax: (905) 738-4862

E-Mail: sales@duramill.ca

Note: All information regarding our products, and in particular the illustrations, drawings, dimensional and performance data contained in this printed matter as well as other technical data are to be regarded as approximate average values. We, therefore, reserve the right to make changes to the corresponding designs. The stated standards, similar technical regulations, descriptions and illustrations of the products were valid at the time of printing. In addition, the products are subject to Canadian Export Administration Regulations. Re-export or relocation of Mitutoyo products may require prior approval by an appropriate governing authority.

Trademarks and Registrations: Designations used by companies to distinguish their products are often claimed as trademarks. In all instances where Mitutoyo Canada Inc. is aware of a claim, the product names appear in initial capital or all capital letters. The appropriate companies should be contacted for more complete trademark and registration information.

Mitutoyo Canada Inc.

www.mitutoyo.ca

Toronto

2121 Meadowvale Blvd.
Mississauga, ON L5N 5N1
Tel. (905) 821-1261

Montreal

7075 Place Robert-Joncas, Suite 129
Montreal, QC H4M 2Z2
Tel. (514) 337-5994

Mitutoyo

Precision is our profession